

Circuit breaker DX³ 10000 A up to 63A (1 module per pole)

Cat. N° (s) : 4 088 64 to 4 093 42



CONTENTS	PAGE
1. Description - Use	1
2. Range.....	1
3. Overall dimensions	1
4. Preparation - Connection	1
5. General Characteristics	2
6. Compliance and approvals.....	27
7. Curves	28
8. Auxiliaries and accessories	38

1. DESCRIPTION - USE:

. Thermal-magnetic circuit breaker (MCB) with positive contact indication for control, protection against short-circuits and overloads, and isolation of electrical circuits.

Symbol:



Technology:

. Limiting device

2. RANGE

Polarity:

. 1P / 2P / 3P / 4P

Width:

. 1 module per pole. Each pole is 17,7 mm

Rated currents, In:

. 0,5 / 1 / 2 / 3 / 4 / 6 / 10 / 13 / 16 / 20 / 25 / 32 / 40 / 50 / 63A B and C curves

Magnetic tripping curves:

. B Curve (between 3 and 5 In)
. C Curve (between 5 and 10 In)

Thermal threshold according to IEC/EN 60898-1:

. Non operating current (In_f): 1,13 In.
. Operating current (I_f): 1,45 In.

Rated Voltage and Frequency:

. 230 V ~ / 400 V ~ - 50 / 60 Hz with standard tolerances
. 80 V per pole DC current

Maximum operating voltage:

. 440 V ~ with possible derating of the breaking capacity

Breaking capacity:

. 10000 A in accordance with standard EN/IEC 60898-1

3. OVERALL DIMENSIONS:

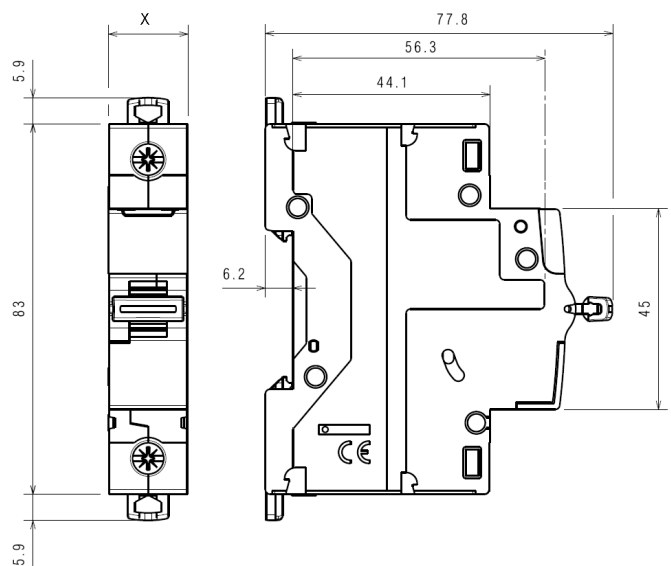

	X
1P	17.7 mm
2P	35.4 mm
3P	53.1 mm
4P	70.8 mm

4. PREPARATION - CONNECTION

Fixing:

. On symmetrical EN/IEC 60715 or DIN 35 rail.

Operating positions:

. Vertical Horizontal Upside down On the side

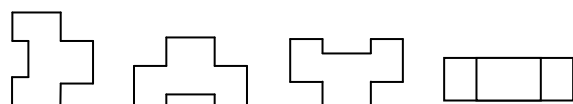

Circuit breaker DX³ 10000 A up to 63A monoconnect (1 module per pole)

Cat. N° (s) : 4 088 64 to 4 093 42

4. PREPARATION - CONNECTION *(continued)*

Power supply:

- . From the top or the bottom.

Connection:

- . Inputs and outputs via screw terminals
- The location of the terminals allows supplying by traditional HX³ pin busbar and fork busbar.

Terminal depth :

- . 14 mm

Stripping length recommended:

- . 11 mm

Screw head:

- . Mixed, slotted and Pozidriv 2.

Tightening torque:

- . Recommended: 2.5 Nm.
- . Mini : 2 Nm. Maxi : 3 Nm.

Tools required:

- . For the terminals: Pozidriv n°2 or flat screwdriver 5,5 mm (6 mm maximum).
- . For fixing: flat screwdriver 5,5 mm (6 mm maximum).

Conductor type:

	Copper cables	
	Without ferrule	With ferrule
Rigid cable	1 x 1,5 mm ² to 35 mm ² 2 x 1,5 mm ² to 16 mm ²	-
Flexible cable	1 x 1,5 mm ² to 25 mm ² 2 x 1,5 mm ² to 10 mm ²	1 x 1,5 mm ² to 25 mm ²

Manual actuation of the MCB:

- . By the 2-position ergonomic handle:
 - "I – ON": Closed circuit.
 - "0 – OFF": Opened circuit.

Contact status display:

- . By marking of the handle
 - "O-OFF" in white on a green background = contacts open
 - "I-ON" in white on a red background = contacts closed

Sealing:

- . Possible in "Open" position (OFF) or "Close" position (ON).

Locking:

- . By 5 mm padlock (cat. N° 4 063 13) or 6 mm padlock (cat. N° 0 227 97) with padlock support (cat. N° 0 044 42).

Labelling:

- . Circuit identification by way of a label inserted in the label holder situated on the front of the product.

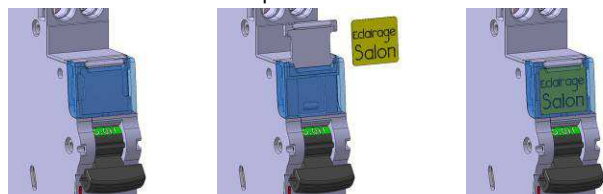

5. GENERAL CHARACTERISTICS:

Marking on the front side:

- . By permanent ink pad printing:
 - Trade name: DX³
 - Breaking curve
 - Rated current (in A)
 - I_{cn} in kA rated breaking capacity in accordance with IEC/EN 60898-1 (in a box)
 - Limiting class "3" (in a square) for the MCB B and C curves with rated current ≤ 40 A.
 - Legrand reference code and Logo
 - Mark: Legrand.



Short-circuit breaking capacity:

- . Alternate current 50/60Hz, single-phase or three-phase network, in accordance with standard: EN/IEC 60898-1

Un		1P	2P	3P / 4P
110 V~	I _{cn}	16000 A	25000 A	-
230V~		10000 A	16000 A	16000 A
400V~		-	10000 A	10000 A
440 V~		-	8000 A	8000 A

Un				
110 V~	I _{cs}	75% of I _{cn}	75% of I _{cn}	75% of I _{cn}
230V~				
400V~				
440 V~				

Short-circuit breaking capacity of only one pole:

- . Three-phase network 220 / 380 V~ to 240 / 415 V~
 - in TN neutral system, I_{cn1} = 16 kA (under 220 to 240 V~)
 - in IT neutral system, I_{lit} = 4 kA (under 380 to 415 V~)
- . Three-phase network 110 / 220 V~ to 120 / 240 V~
 - in TN neutral system, I_{cn1} = 32 kA (under 110 to 127 V~)
 - in IT neutral system, I_{lit} = 8 kA (under 220 to 240 V~)

Circuit breaker DX³ 10000 A up to 63A monoconnect (1 module per pole)

Cat. N° (s) : 4 088 64 to 4 093 42

5. GENERAL CHARACTERISTICS *(continued)*

Minimum operating voltage:

- . 12 V a.c. / d.c. per pole.

Pulse rated voltage:

- . U_{imp} = 4 kV

Insulation rated voltage:

- . U_i = 500 V

Pollution degree :

- . 2 in accordance with the standard EN/IEC 60898-1.

Electric strength:

- . 2500 V

Operation at 400Hz:

- . The magnetic thresholds increase by 45%.

Load to close and to open a pole trough the handle:

- . 0,1 Nm per pole to close.
- . 0,075 Nm per pole to open.

Mechanical endurance:

- . 20000 operation without load.
- . 10000 operation with load (under $I_n \cdot \cos \varphi = 0,9$).
- . 2000 operation under I_n , DC current.

Enclosure material:

- . Polyester.
- . Characteristics of this material: self extinguishing, heat and fire resistant according to EN 60898-1, glow-wire test at 960°C for external parts made of insulating material necessary to retain in position current-carrying parts and parts of protective circuit (650°C for all other external parts made of insulating material).

Average weight per pole:

- . 0,150 kg.

Volume when packed:

	Volume (dm ³)
Single pole	0,163
Double pole	0,334
Triple pole / Four pole	0,680

Ambient temperatures:

- . Operation: from - 25°C to + 70°C
- . Storage: from - 40°C to + 70°C

5. GENERAL CHARACTERISTICS *(continued)*

Protection class:

- . Protection index of terminals against solid and liquid bodies:
IP 20 (wired terminals), (in accordance with standards IEC 529, EN 60529 and NF C 20-010).
- . Protection index of the box against solid and liquid bodies:
IP 40 (in accordance with standards IEC 529, EN 60529 and NF C 20-010).
- . Protection index against mechanical shocks:
IK 02 (in accordance with standards EN 50102 and NF C 20-015).

Sinusoidal vibration resistance in accordance with IEC 60068.2.6:

- . Axis : x, y, z.
- . Frequency range: 5÷100 Hz ; duration 90 minutes
- . Displacement (5÷13,2 Hz) : 1mm
- . Acceleration (13,2÷100 Hz) : 0,7g (g=9,81 m/s²)

Recognition:

- . Recognition of the circuits by label in the "label holder" on the front-side of the MCB

Power dissipated per pole (W) :

- . Circuit breaker B and C curves

I _n	0,5 A	1 A	2 A	3 A	4 A	6 A	10 A
1P÷4P	1.7	2	2	2	2	1,1	1.8

I _n	16 A	20 A	25 A	32 A	40 A	50A	63A
1P÷4P	2	2.4	2.7	3.2	4	4.5	5,5

- . Impedance per pole (Ω) = $\frac{P \text{ dissipated}}{I_n^2}$

Circuit breaker DX³ 10000 A up to 63A monoconnect (1 module per pole)

Cat. N° (s) : 4 088 64 to 4 093 42

5. GENERAL CHARACTERISTICS *(continued)*:

Derating of circuit-breakers according to ambient temperature :

. The nominal characteristics of a circuit breaker are modified according to the ambient temperature inside the cabinet or the enclosure where the circuit breaker is located.

. Reference temperature: 30°C in accordance with EN/IEC 60898-1

In (A)	Ambient Temperature / In									
	- 25°C	- 10°C	0°C	10°C	20°C	30°C	40°C	50°C	60°C	70°C
0.5	0.62	0.6	0.57	0.55	0.52	0.5	0.47	0.42	0.40	0.38
1	1.5	1.4	1.3	1.2	1.1	1	0.9	0.8	0.7	0.6
1.5	1.9	1.8	1.7	1.7	1.6	1.5	1.5	1.4	1.4	1.3
2	2.8	2.6	2.5	2.3	2.2	2	2	1.9	1.8	1.7
3	3.8	3.6	3.5	3.3	3.2	3.0	2.9	2.8	2.7	2.6
3.5	4.5	4.2	4.0	3.9	3.7	3.5	3.4	3.3	3.2	3.1
5	6.4	6.0	5.8	5.5	5.3	5.0	4.8	4.7	4.5	4.6
6	7.5	7.0	6.6	6.4	6.2	6.0	5.8	5.6	5.4	5.3
10	12.5	11.5	11.1	10.7	10.3	10.0	9.7	9.3	9.0	8.7
13	16.3	15.0	14.3	13.9	13.4	13.0	12.6	12.1	11.7	11.3
16	20.0	18.7	18.0	17.3	16.6	16.0	15.4	14.7	14.1	13.5
20	25.0	23.2	22.4	21.6	20.8	20.0	19.2	18.4	17.6	16.8
25	31.5	29.5	28.3	27.2	26.0	25.0	24.0	22.7	21.7	20.7
30	38.3	36.0	34.5	33.0	31.5	30.0	28.8	27.3	26.1	24.9
32	41.0	37.8	36.5	34.9	33.3	32.0	30.7	29.1	27.8	26.5
40	51.0	48.0	46.0	44.0	42.0	40.0	38.0	36.0	34.0	32.0
50	64.0	60.0	57.5	55.0	52.5	50.0	47.5	45.0	42.5	40.0
63	80.6	75.6	72.5	69.9	66.1	63.0	59.8	56.1	52.9	49.7

Derating of MCB for use with fluorescent lights:

Ferromagnetic and electronic ballasts have a high inrush current for a short time. These currents can cause the tripping of circuit breakers.

At the time of the installation, it should take into account the maximum number of ballasts per circuit breaker that the manufacturers of lamps and ballasts indicate in their catalogues.

Influence of the altitude:

	≤2000 m	3000 m	4000 m	5000 m
Dielectric holding	3000 V	2500 V	2000 V	1500 V
Max operational Voltage	400 V	400 V	400 V	400 V
Derating at 30°C	none	none	none	none

Derating of MCBs function of the number of devices side by side:

When several MCBs are juxtaposed and operate simultaneously, the thermal evacuation of the poles is limited. This results in an increase in operating temperature of the circuit breakers which can cause unwanted tripping. It is recommended to apply the following coefficients to the rated currents.

Number of circuit breakers side by side	Coefficient
2 - 3	0.9
4 - 5	0.8
6 - 9	0.7
≥ 10	0.6

These values are given by the recommendation of IEC 60439-1, NF C 63421 and EN 60439-1 standards.

To avoid using these coefficients, it is necessary to allow a good ventilation and to separate the devices with 0.5 module spacing elements (cat. N° 4 063 07).

Circuit breaker DX³ 10000 A up to 63A monoconnect (1 module per pole)

Cat. N° (s) : 4 088 64 to 4 093 42

5. GENERAL CHARACTERISTICS *(continued)*:

Coordination between circuit-breakers and fuses, three-phase network (+ neutral) 400 / 415 V~ according to IEC/EN 60947-2:

For TT or TN neutral system in 230/400 V network, to know the breaking capacity of the combination of a double pole breaker (connected between phase and neutral under 230V) downstream of a triple-pole circuit-breaker, take the values shown in Tables 230/400V.

m.c.b. downstream		Fuse upstream										
		gG Type										
		≤20A	25A	32A	40A	50A	63A	80A	100A	125A	160A	
DX ³ 10000A B and C Curves	≤6A	100kA	100kA	100kA	100kA	100kA	100kA	100kA	100kA	100kA	100kA	40kA
	10A	100kA	100kA	100kA	100kA	100kA	100kA	100kA	100kA	100kA	100kA	40kA
	13A	100kA	100kA	100kA	100kA	100kA	100kA	100kA	100kA	100kA	100kA	40kA
	16A	-	100kA	100kA	100kA	100kA	100kA	100kA	100kA	100kA	100kA	40kA
	20A	-	-	100kA	100kA	100kA	100kA	100kA	100kA	100kA	100kA	40kA
	25A	-	-	-	100kA	100kA	100kA	100kA	100kA	100kA	100kA	40kA
	32A	-	-	-	-	100kA	100kA	100kA	100kA	100kA	100kA	40kA
	40A	-	-	-	-	-	100kA	100kA	100kA	100kA	100kA	40kA
	50A	-	-	-	-	-	-	100kA	100kA	100kA	100kA	40kA
	63A	-	-	-	-	-	-	100kA	100kA	100kA	100kA	40kA

m.c.b. downstream		Fuse upstream										
		aM Type										
		≤20A	25A	32A	40A	50A	63A	80A	100A	125A	160A	
DX ³ 10000A B and C Curves	≤6A	100kA	100kA	100kA	100kA	100kA	100kA	100kA	100kA	100kA	100kA	40kA
	10A	100kA	100kA	100kA	100kA	100kA	100kA	100kA	100kA	100kA	100kA	40kA
	13A	100kA	100kA	100kA	100kA	100kA	100kA	100kA	100kA	100kA	100kA	40kA
	16A	-	100kA	100kA	100kA	100kA	100kA	100kA	100kA	100kA	100kA	40kA
	20A	-	-	100kA	100kA	100kA	100kA	100kA	100kA	100kA	100kA	40kA
	25A	-	-	-	100kA	100kA	100kA	100kA	100kA	100kA	100kA	40kA
	32A	-	-	-	-	100kA	100kA	100kA	100kA	100kA	100kA	40kA
	40A	-	-	-	-	-	100kA	100kA	100kA	100kA	100kA	40kA
	50A	-	-	-	-	-	-	100kA	100kA	100kA	100kA	40kA
	63A	-	-	-	-	-	-	100kA	100kA	100kA	100kA	40kA

All these values are also valid for circuit breakers associated to RCD add-on modules.

According to the curves and ratings of circuit breakers, attention to the threshold and size of upstream fuse which must necessarily be higher.

Circuit breaker DX³ 10000 A up to 63A monoconnect (1 module per pole)

Cat. N° (s) : 4 088 64 to 4 093 42

5. GENERAL CHARACTERISTICS *(continued)*:

Coordination between modular circuit-breakers, three-phase network (+ neutral) 400 / 415 V~ according to IEC/EN 60947-2:

For TT or TN neutral system in 230/400 V network, to know the breaking capacity of the combination of a double pole breaker (connected between phase and neutral under 230V) downstream of a triple-pole circuit-breaker, take the values shown in Tables 230/400V.

		m.c.b. upstream							
		DX ³ 25kA							
		B, C and D Curves							
m.c.b. downstream		≤25A	32A	40A	50A	63A	80A	100A	125A
DX ³ 10000A B and C Curves	≤6A	25kA	25kA	25kA	25kA	25kA	25kA	25kA	25kA
	10A	25kA	25kA	25kA	25kA	25kA	25kA	25kA	25kA
	13A	25kA	25kA	25kA	25kA	25kA	25kA	25kA	25kA
	16A	25kA	25kA	25kA	25kA	25kA	25kA	25kA	25kA
	20A	25kA	25kA	25kA	25kA	25kA	25kA	25kA	25kA
	25A	-	25kA	25kA	25kA	25kA	25kA	25kA	25kA
	32A	-	-	25kA	25kA	25kA	25kA	25kA	25kA
	40A	-	-	-	25kA	25kA	25kA	25kA	25kA
	50A	-	-	-	-	25kA	25kA	25kA	25kA
	63A	-	-	-	-	-	25kA	25kA	25kA

All these values are also valid for circuit breakers associated to RCD add-on modules.

According to the curves and ratings of circuit breakers, attention to the magnetic threshold and to the size of upstream circuit breakers which must necessarily be higher.

Circuit breaker DX³ 10000 A up to 63A monoconnect (1 module per pole)

Cat. N° (s) : 4 088 64 to 4 093 42

5. GENERAL CHARACTERISTICS *(continued)*:

Coordination between modular circuit-breakers, three-phase network (+ neutral) 400 / 415 V~ according to IEC/EN 60947-2:

For TT or TN neutral system in 230/400 V network, to know the breaking capacity of the combination of a double pole breaker (connected between phase and neutral under 230V) downstream of a triple-pole circuit-breaker, take the values shown in Tables 230/400V.

		m.c.b. upstream										
		DX ³ 36kA						DX ³ 50kA				
		C Curve						B,C and D Curves				
m.c.b. downstream		≤25A	32A	40A	50A	63A	80A	≤25A	32A	40A	50A	63A
DX ³ 10000A B and C Curves	≤6A	36kA	36kA	36kA	36kA	36kA	36kA	50kA	50kA	50kA	50kA	50kA
	10A	36kA	36kA	36kA	36kA	36kA	36kA	50kA	50kA	50kA	50kA	50kA
	13A	36kA	36kA	36kA	36kA	36kA	36kA	50kA	50kA	50kA	50kA	50kA
	16A	36kA	36kA	36kA	36kA	36kA	36kA	50kA	50kA	50kA	50kA	50kA
	20A	36kA	36kA	36kA	36kA	36kA	36kA	50kA	50kA	50kA	50kA	50kA
	25A	-	36kA	36kA	36kA	36kA	36kA	-	50kA	50kA	50kA	50kA
	32A	-	-	36kA	36kA	36kA	36kA	-	-	50kA	50kA	50kA
	40A	-	-	-	36kA	36kA	36kA	-	-	-	50kA	50kA
	50A	-	-	-	-	36kA	36kA	-	-	-	-	50kA
63A	-	-	-	-	-	36kA	-	-	-	-	-	

All these values are also valid for circuit breakers associated to RCD add-on modules.

According to the curves and ratings of circuit breakers, attention to the magnetic threshold and to the size of upstream circuit breakers which must necessarily be higher.

Circuit breaker DX³ 10000 A up to 63A monoconnect (1 module per pole)

Cat. N° (s) : 4 088 64 to 4 093 42

5. GENERAL CHARACTERISTICS (continued):

Coordination between modular circuit-breakers and MCCBs, three-phase network (+ neutral) 400 / 415 V~ according to IEC/EN60947-2:

For TT or TN neutral system in 230/400 V network, to know the breaking capacity of the combination of a double pole breaker (connected between phase and neutral under 230V) downstream of a triple-pole circuit-breaker, take the values shown in Tables 230/400V.

m.c.b. downstream		m.c.c.b. upstream											
		DPX 125						DPX 125					
		16kA						25kA					
		16A	25A	40A	63A	100A	125A	16A	25A	40A	63A	100A	125A
DX ³ 10000A B and C Curves	≤6A	16kA	16kA	16kA	16kA	16kA	16kA	25kA	25kA	25kA	25kA	25kA	25kA
	10A	16kA	16kA	16kA	16kA	16kA	16kA	25kA	25kA	25kA	25kA	25kA	25kA
	13A	16kA	16kA	16kA	16kA	16kA	16kA	25kA	25kA	25kA	25kA	25kA	25kA
	16A	-	16kA	16kA	16kA	16kA	16kA	-	25kA	25kA	25kA	25kA	25kA
	20A	-	16kA	16kA	16kA	16kA	16kA	-	25kA	25kA	25kA	25kA	25kA
	25A	-	-	16kA	16kA	16kA	16kA	-	-	25kA	25kA	25kA	25kA
	32A	-	-	16kA	16kA	16kA	16kA	-	-	25kA	25kA	25kA	25kA
	40A	-	-	-	16kA	16kA	16kA	-	-	-	25kA	25kA	25kA
	50A	-	-	-	16kA	16kA	16kA	-	-	-	25kA	25kA	25kA
	63A	-	-	-	-	16kA	16kA	-	-	-	-	25kA	25kA

m.c.b. downstream		m.c.c.b. upstream													
		DPX 125							DPX ³ 160 / DPX ³ 160 + RCD						
		36kA							16kA						
		16A	25A	40A	63A	100A	125A	16A	25A	40A	63A	80A	100A	125A	160A
DX ³ 10000A B and C Curves	≤6A	25kA	25kA	25kA	25kA	25kA	25kA	16kA	16kA	16kA	16kA	16kA	16kA	16kA	16kA
	10A	25kA	25kA	25kA	25kA	25kA	25kA	16kA	16kA	16kA	16kA	16kA	16kA	16kA	16kA
	13A	25kA	25kA	25kA	25kA	25kA	25kA	16kA	16kA	16kA	16kA	16kA	16kA	16kA	16kA
	16A	-	25kA	25kA	25kA	25kA	25kA	-	16kA	16kA	16kA	16kA	16kA	16kA	16kA
	20A	-	25kA	25kA	25kA	25kA	25kA	-	16kA	16kA	16kA	16kA	16kA	16kA	16kA
	25A	-	-	25kA	25kA	25kA	25kA	-	-	16kA	16kA	16kA	16kA	16kA	16kA
	32A	-	-	25kA	25kA	25kA	25kA	-	-	16kA	16kA	16kA	16kA	16kA	16kA
	40A	-	-	-	25kA	25kA	25kA	-	-	-	16kA	16kA	16kA	16kA	16kA
	50A	-	-	-	25kA	25kA	25kA	-	-	-	16kA	16kA	16kA	16kA	16kA
	63A	-	-	-	-	25kA	25kA	-	-	-	-	16kA	16kA	16kA	16kA

All these values are also valid for circuit breakers associated to RCD add-on modules.

According to the curves and ratings of circuit breakers, attention to the magnetic threshold and to the size of upstream circuit breakers which must necessarily be higher.

Circuit breaker DX³ 10000 A up to 63A monoconnect (1 module per pole)

Cat. N° (s) : 4 088 64 to 4 093 42

5. GENERAL CHARACTERISTICS (continued):

Coordination between modular circuit-breakers and MCCBs, three-phase network (+ neutral) 400 / 415 V~ according to IEC/EN60947-2:

For TT or TN neutral system in 230/400 V network, to know the breaking capacity of the combination of a double pole breaker (connected between phase and neutral under 230V) downstream of a triple-pole circuit-breaker, take the values shown in Tables 230/400V.

m.c.b. downstream		m.c.c.b. upstream												
		DPX ³ 160 / DPX ³ 160 + RCD								DPX 160				
		25 - 36 - 50kA								25 - 36 - 50kA				
		16A	25A	40A	63A	80A	100A	125A	160A	25A	40A	63A	100A	125A
DX ³ 10000A B and C Curves	≤6A	25kA	25kA	25kA	25kA	25kA	25kA	25kA	25kA	25kA	25kA	25kA	25kA	25kA
	10A	25kA	25kA	25kA	25kA	25kA	25kA	25kA	25kA	25kA	25kA	25kA	25kA	25kA
	13A	25kA	25kA	25kA	25kA	25kA	25kA	25kA	25kA	25kA	25kA	25kA	25kA	25kA
	16A	-	25kA	25kA	25kA	25kA	25kA	25kA	25kA	25kA	25kA	25kA	25kA	25kA
	20A	-	25kA	25kA	25kA	25kA	25kA	25kA	25kA	25kA	25kA	25kA	25kA	25kA
	25A	-	-	25kA	25kA	25kA	25kA	25kA	25kA	-	25kA	25kA	25kA	25kA
	32A	-	-	25kA	25kA	25kA	25kA	25kA	25kA	-	25kA	25kA	25kA	25kA
	40A	-	-	-	25kA	25kA	25kA	25kA	25kA	-	-	25kA	25kA	25kA
	50A	-	-	-	25kA	25kA	25kA	25kA	25kA	-	-	25kA	25kA	25kA
	63A	-	-	-	-	25kA	25kA	25kA	25kA	-	-	-	20kA	20kA

m.c.b. downstream		m.c.c.b. upstream												
		DPX 250ER			DPX 250ER AB				DPX ³ 250 / DPX ³ 250+RCD (Thermal-magnetic & electronic)				DPX 400AB	
		25 - 36 - 50kA			36kA				25 - 36 - 50 - 70kA				36kA	
		100A	160A	250A	90A	130A	170A	240A	100A	160A	200A	250A	320A	400A
DX ³ 10000A B and C Curves	≤6A	25kA	25kA	25kA	25kA	25kA	25kA	25kA	25kA	25kA	25kA	25kA	25kA	25kA
	10A	25kA	25kA	25kA	25kA	25kA	25kA	25kA	25kA	25kA	25kA	25kA	25kA	25kA
	13A	25kA	25kA	25kA	25kA	25kA	25kA	25kA	25kA	25kA	25kA	25kA	25kA	25kA
	16A	25kA	25kA	25kA	25kA	25kA	25kA	25kA	25kA	25k□	25kA	25kA	25kA	25kA
	20A	25kA	25kA	25kA	25kA	25kA	25kA	25kA	25kA	25kA	25kA	25kA	25kA	25kA
	25A	25kA	25kA	25kA	25kA	25kA	25kA	25kA	25kA	25kA	25kA	25kA	25kA	25kA
	32A	25kA	25kA	25kA	25kA	25kA	25kA	25kA	25kA	25kA	25kA	25kA	25kA	25kA
	40A	25kA	25kA	25kA	25kA	25kA	25kA	25kA	25kA	25kA	25kA	25kA	20kA	20kA
	50A	25kA	25kA	25kA	25kA	25kA	25kA	25kA	25kA	25kA	25kA	25kA	16kA	16kA
	63A	20kA	20kA	20kA	20kA	20kA	20kA	20kA	20kA	25kA	25kA	25kA	16kA	16kA

All these values are also valid for circuit breakers associated to RCD add-on modules.

According to the curves and ratings of circuit breakers, attention to the magnetic (or electronic) threshold and to the size of upstream circuit breakers which must necessarily be higher.

Circuit breaker DX³ 10000 A up to 63A monoconnect (1 module per pole)

Cat. N° (s) : 4 088 64 to 4 093 42

5. GENERAL CHARACTERISTICS (continued):

Coordination between modular circuit-breakers and MCCBs, three-phase network (+ neutral) 400 / 415 V~ according to IEC/EN60947-2:

For TT or TN neutral system in 230/400 V network, to know the breaking capacity of the combination of a double pole breaker (connected between phase and neutral under 230V) downstream of a triple-pole circuit-breaker, take the values shown in Tables 230/400V.

m.c.b. downstream		m.c.c.b. upstream										
		DPX / H / L 250 (Thermal-magnetic & electronic)						DPX / H / L 630 (Thermal-magnetic & electronic)				
		36 – 70 – 100kA						36 – 70 – 100kA				
		25A	40A	63A	100A	160A	250A	250A	320A	400A	500A	630A
DX ³ 10000A B and C Curves	≤6A	25kA	25kA	25kA	25kA	25kA	25kA	25kA	25kA	25kA	25kA	25kA
	10A	25kA	25kA	25kA	25kA	25kA	25kA	25kA	25kA	25kA	25kA	25kA
	13A	25kA	25kA	25kA	25kA	25kA	25kA	25kA	25kA	25kA	25kA	25kA
	16A	25kA	25kA	25kA	25kA	25kA	25kA	25kA	25kA	25kA	25kA	25kA
	20A	25kA	25kA	25kA	25kA	25kA	25kA	25kA	25kA	25kA	25kA	25kA
	25A	-	25kA	25kA	25kA	25kA	25kA	25kA	25kA	25kA	25kA	25kA
	32A	-	25kA	25kA	25kA	25kA	25kA	25kA	25kA	25kA	25kA	25kA
	40A	-	-	25kA	25kA	25kA	25kA	20kA	20kA	20kA	20kA	20kA
	50A	-	-	25kA	25kA	25kA	25kA	16kA	16kA	16kA	16kA	16kA
63A	-	-	20kA	20kA	20kA	20kA	16kA	16kA	16kA	16kA	16kA	

m.c.b. downstream		m.c.c.b.. upstream	
		DPX / H / L 1250 (Thermal -magnetic)	DPX / H 1600 (electronic)
		50 – 70 – 100kA	36 – 70kA
		500 to 1250A	630 to 1600A
DX ³ 10000A B and C Curves	≤6A	25kA	25kA
	10A	25kA	25kA
	13A	25kA	25kA
	16A	25kA	25kA
	20A	25kA	25kA
	25A	20kA	20kA
	32A	15kA	15kA
	40A	15kA	15kA
	50A	12,5kA	12,5kA
63A	12,5kA	12,5kA	

All these values are also valid for circuit breakers associated to RCD add-on modules.

According to the curves and ratings of circuit breakers, attention to the magnetic (or electronic) threshold and to the size of upstream circuit breakers which must necessarily be higher.

Circuit breaker DX³ 10000 A up to 63A monoconnect (1 module per pole)

Cat. N° (s) : 4 088 64 to 4 093 42

5. GENERAL CHARACTERISTICS *(continued)*:

Coordination between modular circuit-breakers and fuses, three-phase network (+ neutral) 230 / 240 V~ according to IEC/EN 60947-2:

m.c.b. downstream		Fuse upstream										
		gG Type										
		≤20A	25A	32A	40A	50A	63A	80A	100A	125A	160A	
DX ³ 10000A B and C Curves	≤6A	100kA	100kA	100kA	100kA	100kA	100kA	100kA	100kA	100kA	100kA	40kA
	10A	100kA	100kA	100kA	100kA	100kA	100kA	100kA	100kA	100kA	100kA	40kA
	13A	100kA	100kA	100kA	100kA	100kA	100kA	100kA	100kA	100kA	100kA	40kA
	16A	-	100kA	100kA	100kA	100kA	100kA	100kA	100kA	100kA	100kA	40kA
	20A	-	-	100kA	100kA	100kA	100kA	100kA	100kA	100kA	100kA	40kA
	25A	-	-	-	100kA	100kA	100kA	100kA	100kA	100kA	100kA	40kA
	32A	-	-	-	-	100kA	100kA	100kA	100kA	100kA	100kA	40kA
	40A	-	-	-	-	-	100kA	100kA	100kA	100kA	100kA	40kA
	50A	-	-	-	-	-	-	100kA	100kA	100kA	100kA	40kA
	63A	-	-	-	-	-	-	100kA	100kA	100kA	100kA	40kA

m.c.b. downstream		Fuse upstream										
		aM Type										
		≤20A	25A	32A	40A	50A	63A	80A	100A	125A	160A	
DX ³ 10000A B and C Curves	≤6A	100kA	100kA	100kA	100kA	100kA	100kA	100kA	100kA	100kA	100kA	40kA
	10A	100kA	100kA	100kA	100kA	100kA	100kA	100kA	100kA	100kA	100kA	40kA
	13A	100kA	100kA	100kA	100kA	100kA	100kA	100kA	100kA	100kA	100kA	40kA
	16A	-	100kA	100kA	100kA	100kA	100kA	100kA	100kA	100kA	100kA	40kA
	20A	-	-	100kA	100kA	100kA	100kA	100kA	100kA	100kA	100kA	40kA
	25A	-	-	-	100kA	100kA	100kA	100kA	100kA	100kA	100kA	40kA
	32A	-	-	-	-	100kA	100kA	100kA	100kA	100kA	100kA	40kA
	40A	-	-	-	-	-	100kA	100kA	100kA	100kA	100kA	40kA
	50A	-	-	-	-	-	-	100kA	100kA	100kA	100kA	40kA
	63A	-	-	-	-	-	-	100kA	100kA	100kA	100kA	40kA

All these values are also valid for circuit breakers associated to RCD add-on modules.

According to the curves and ratings of circuit breakers, attention to the threshold and to the size of upstream fuses which must necessarily be higher.

Circuit breaker DX³ 10000 A up to 63A monoconnect (1 module per pole)

Cat. N° (s) : 4 088 64 to 4 093 42

5. GENERAL CHARACTERISTICS *(continued)*:

Coordination between modular circuit-breakers, three-phase network (+ neutral) 230 / 240 V~ according to IEC/EN 60947-2:

		m.c.b. upstream							
		DX ³ 25kA							
		B, C and D Curves							
m.c.b. downstream		≤25A	32A	40A	50A	63A	80A	100A	125A
DX ³ 10000A B and C Curves	≤6A	50kA	50kA	25kA	25kA	25kA	25kA	25kA	25kA
	10A	50kA	50kA	25kA	25kA	25kA	25kA	25kA	25kA
	13A	50kA	50kA	25kA	25kA	25kA	25kA	25kA	25kA
	16A	50kA	50kA	25kA	25kA	25kA	25kA	25kA	25kA
	20A	50kA	50kA	25kA	25kA	25kA	25kA	25kA	25kA
	25A	-	50kA	25kA	25kA	25kA	25kA	25kA	25kA
	32A	-	-	25kA	25kA	25kA	25kA	25kA	25kA
	40A	-	-	-	25kA	25kA	25kA	25kA	25kA
	50A	-	-	-	-	25kA	25kA	25kA	25kA
	63A	-	-	-	-	-	25kA	25kA	25kA

All these values are also valid for circuit breakers associated to RCD add-on modules.

According to the curves and ratings of circuit breakers, attention to the magnetic threshold and to the size of upstream circuit breakers which must necessarily be higher.

Circuit breaker DX³ 10000 A up to 63A monoconnect (1 module per pole)

Cat. N° (s) : 4 088 64 to 4 093 42

5. GENERAL CHARACTERISTICS *(continued)*:

Coordination between modular circuit-breakers, three-phase network (+ neutral) 230 / 240 V~ according to IEC/EN 60947-2:

m.c.b. downstream		m.c.b. upstream										
		DX ³ 36kA					DX ³ 50kA					
		C Curve					B, C and D Curves					
		≤25A	32A	40A	50A	63A	80A	≤25A	32A	40A	50A	63A
DX ³ 10000A B and C Curves	≤6A	50kA	50kA	50kA	50kA	50kA	50kA	50kA	50kA	50kA	50kA	50kA
	10A	50kA	50kA	50kA	50kA	50kA	50kA	50kA	50kA	50kA	50kA	50kA
	13A	50kA	50kA	50kA	50kA	50kA	50kA	50kA	50kA	50kA	50kA	50kA
	16A	50kA	50kA	50kA	50kA	50kA	50kA	50kA	50kA	50kA	50kA	50kA
	20A	50kA	50kA	50kA	50kA	50kA	50kA	50kA	50kA	50kA	50kA	50kA
	25A	-	50kA	50kA	50kA	50kA	50kA	-	50kA	50kA	50kA	50kA
	32A	-	-	50kA	50kA	50kA	50kA	-	-	50kA	50kA	50kA
	40A	-	-	-	50kA	50kA	50kA	-	-	-	50kA	50kA
	50A	-	-	-	-	50kA	50kA	-	-	-	-	50kA
63A	-	-	-	-	-	50kA	-	-	-	-	-	

All these values are also valid for circuit breakers associated to RCD add-on modules.

According to the curves and ratings of circuit breakers, attention to the magnetic threshold and to the size of upstream circuit breakers which must necessarily be higher.

Circuit breaker DX³ 10000 A up to 63A monoconnect (1 module per pole)

Cat. N° (s) : 4 088 64 to 4 093 42

5. GENERAL CHARACTERISTICS *(continued)*:

Coordination between modular circuit-breakers and M.C.C.Bs (Moulded Case Circuit Breakers), three-phase network (+ neutral)
230 / 240 V~ according to IEC/EN 60947-2:

		m.c.c.b. upstream											
		DPX 125						DPX 125					
		25kA						36kA					
m.c.b. downstream		16A	25A	40A	63A	100A	125A	16A	25A	40A	63A	100A	125A
DX ³ 10000A B and C Curves	≤6A	35kA	35kA	35kA	35kA	35kA	35kA	40kA	40kA	40kA	40kA	40kA	40kA
	10A	35kA	35kA	35kA	35kA	35kA	35kA	40kA	40kA	40kA	40kA	40kA	40kA
	13A	35kA	35kA	35kA	35kA	35kA	35kA	40kA	40kA	40kA	40kA	40kA	40kA
	16A	-	35kA	35kA	35kA	35kA	35kA	-	40kA	40kA	40kA	40kA	40kA
	20A	-	35kA	35kA	35kA	35kA	35kA	-	40kA	40kA	40kA	40kA	40kA
	25A	-	-	35kA	35kA	35kA	35kA	-	-	40kA	40kA	40kA	40kA
	32A	-	-	35kA	35kA	35kA	35kA	-	-	40kA	40kA	40kA	40kA
	40A	-	-	-	35kA	35kA	35kA	-	-	-	40kA	40kA	40kA
	50A	-	-	-	25kA	25kA	25kA	-	-	-	25kA	25kA	25kA
	63A	-	-	-	-	25kA	25kA	-	-	-	-	25kA	25kA

		m.c.c.b. upstream							
		DPX ³ 160 / DPX ³ 160 + RCD							
		16kA							
m.c.b. downstream		16A	25A	40A	63A	80A	100A	125A	160A
DX ³ 10000A B and C Curves	≤6A	28kA	28kA	28kA	28kA	28kA	28kA	28kA	28kA
	10A	28kA	28kA	28kA	28kA	28kA	28kA	28kA	28kA
	13A	28kA	28kA	28kA	28kA	28kA	28kA	28kA	28kA
	16A	-	28kA	28kA	28kA	28kA	28kA	28kA	28kA
	20A	-	28kA	28kA	28kA	28kA	28kA	28kA	28kA
	25A	-	-	28kA	28kA	28kA	28kA	28kA	28kA
	32A	-	-	28kA	28kA	28kA	28kA	28kA	28kA
	40A	-	-	-	28kA	28kA	28kA	28kA	28kA
	50A	-	-	-	28kA	28kA	28kA	28kA	28kA
	63A	-	-	-	-	28kA	28kA	28kA	28kA

All these values are also valid for circuit breakers associated to RCD add-on modules.

According to the curves and ratings of circuit breakers, attention to the magnetic threshold and to the size of upstream circuit breakers which must necessarily be higher.

Circuit breaker DX³ 10000 A up to 63A monoconnect (1 module per pole)

Cat. N° (s) : 4 088 64 to 4 093 42

5. GENERAL CHARACTERISTICS *(continued)*:

Coordination between modular circuit-breakers and M.C.C.Bs (Moulded Case Circuit Breakers), three-phase network (+ neutral)
230 / 240 V~ according to IEC/EN 60947-2:

		m.c.c.b. upstream							
		DPX ³ 160 / DPX ³ 160 + RCD							
		25kA							
m.c.b. downstream		16A	25A	40A	63A	80A	100A	125A	160A
DX ³ 10000A B and C Curves	≤6A	40kA	40kA	40kA	40kA	40kA	40kA	40kA	40kA
	10A	40kA	40kA	40kA	40kA	40kA	40kA	40kA	40kA
	13A	40kA	40kA	40kA	40kA	40kA	40kA	40kA	40kA
	16A	-	40kA	40kA	40kA	40kA	40kA	40kA	40kA
	20A	-	40kA	40kA	40kA	40kA	40kA	40kA	40kA
	25A	-	-	40kA	40kA	40kA	40kA	40kA	40kA
	32A	-	-	40kA	40kA	40kA	40kA	40kA	40kA
	40A	-	-	-	40kA	40kA	40kA	40kA	40kA
	50A	-	-	-	40kA	40kA	40kA	40kA	40kA
	63A	-	-	-	-	40kA	40kA	40kA	40kA

		m.c.c.b. upstream							
		DPX ³ 160 / DPX ³ 160 + RCD							
		36 - 50kA							
m.c.b. downstream		16A	25A	40A	63A	80A	100A	125A	160A
DX ³ 10000A B and C Curves	≤6A	50kA	50kA	50kA	50kA	50kA	50kA	50kA	50kA
	10A	50kA	50kA	50kA	50kA	50kA	50kA	50kA	50kA
	13A	50kA	50kA	50kA	50kA	50kA	50kA	50kA	50kA
	16A	-	50kA	50kA	50kA	50kA	50kA	50kA	50kA
	20A	-	50kA	50kA	50kA	50kA	50kA	50kA	50kA
	25A	-	-	50kA	50kA	50kA	50kA	50kA	50kA
	32A	-	-	50kA	50kA	50kA	50kA	50kA	50kA
	40A	-	-	-	50kA	50kA	50kA	50kA	50kA
	50A	-	-	-	50kA	50kA	50kA	50kA	50kA
	63A	-	-	-	-	50kA	50kA	50kA	50kA

All these values are also valid for circuit breakers associated to RCD add-on modules.

According to the curves and ratings of circuit breakers, attention to the magnetic threshold and to the size of upstream circuit breakers which must necessarily be higher.

Circuit breaker DX³ 10000 A up to 63A monoconnect (1 module per pole)

Cat. N° (s) : 4 088 64 to 4 093 42

5. GENERAL CHARACTERISTICS *(continued)*:

Coordination between modular circuit-breakers and M.C.C.Bs (Moulded Case Circuit Breakers), three-phase network (+ neutral)
230 / 240 V~ according to IEC/EN 60947-2:

		m.c.c.b. upstream									
		DPX 160					DPX 160				
		25kA					36 - 50kA				
m.c.b. downstream		25A	40A	63A	100A	125A	25A	40A	63A	100A	125A
DX ³ 10000A B and C Curves	≤6A	40kA	40kA	40kA	40kA	40kA	50kA	50kA	50kA	50kA	50kA
	10A	40kA	40kA	40kA	40kA	40kA	50kA	50kA	50kA	50kA	50kA
	13A	40kA	40kA	40kA	40kA	40kA	50kA	50kA	50kA	50kA	50kA
	16A	40kA	40kA	40kA	40kA	40kA	50kA	50kA	50kA	50kA	50kA
	20A	40kA	40kA	40kA	40kA	40kA	50kA	50kA	50kA	50kA	50kA
	25A	-	-	-	40kA	40kA	-	50kA	50kA	50kA	50kA
	32A	-	-	-	40kA	40kA	-	50kA	50kA	50kA	50kA
	40A	-	-	-	40kA	40kA	-	-	50kA	50kA	50kA
	50A	-	-	-	36kA	36kA	-	-	36kA	36kA	36kA
	63A	-	-	-	30kA	30kA	-	-	-	30kA	30kA

		m.c.c.b. upstream									
		DPX 250ER			DPX 250ER			DPX 250ER AB			
		25kA			36 - 50kA			36kA			
m.c.b. downstream		100A	160A	250A	100A	160A	250A	90A	130A	170A	240A
DX ³ 10000A B and C Curves	≤6A	40kA	40kA	40kA	50kA	50kA	50kA	50kA	50kA	50kA	50kA
	10A	40kA	40kA	40kA	50kA	50kA	50kA	50kA	50kA	50kA	50kA
	13A	40kA	40kA	40kA	50kA	50kA	50kA	50kA	50kA	50kA	50kA
	16A	40kA	40kA	40kA	50kA	50kA	50kA	50kA	50kA	50kA	50kA
	20A	40kA	40kA	40kA	50kA	50kA	50kA	50kA	50kA	50kA	50kA
	25A	40kA	40kA	40kA	50kA	50kA	50kA	50kA	50kA	50kA	50kA
	32A	40kA	40kA	40kA	50kA	50kA	50kA	50kA	50kA	50kA	50kA
	40A	40kA	40kA	40kA	50kA	50kA	50kA	50kA	50kA	50kA	50kA
	50A	36kA	36kA	36kA	36kA	36kA	36kA	36kA	36kA	36kA	36kA
	63A	30kA	30kA	30kA	30kA	30kA	30kA	30kA	30kA	30kA	30kA

All these values are also valid for circuit breakers associated to RCD add-on modules.

According to the curves and ratings of circuit breakers, attention to the magnetic threshold and to the size of upstream circuit breakers which must necessarily be higher.

Circuit breaker DX³ 10000 A up to 63A monoconnect (1 module per pole)

Cat. N° (s) : 4 088 64 to 4 093 42

5. GENERAL CHARACTERISTICS *(continued)*:

Coordination between modular circuit-breakers and M.C.C.Bs (Moulded Case Circuit Breakers), three-phase network (+ neutral)
230 / 240 V~ according to IEC/EN 60947-2:

		m.c.c.b. upstream									
		DPX ³ 250 / DPX ³ 250+RCD (Thermal-magnetic & electronic)				DPX ³ 250 / DPX ³ 250+RCD (Thermal-magnetic & electronic)				DPX 400AB	
		25kA				36 – 50 – 70kA				36kA	
m.c.b. downstream		100A	160A	200A	250A	100A	160A	200A	250A	320A	400A
DX ³ 10000A B and C Curves	≤6A	40kA	40kA	40kA	40kA	50kA	50kA	50kA	50kA	50kA	50kA
	10A	40kA	40kA	40kA	40kA	50kA	50kA	50kA	50kA	50kA	50kA
	13A	40kA	40kA	40kA	40kA	50kA	50kA	50kA	50kA	50kA	50kA
	16A	40kA	40kA	40kA	40kA	50kA	50kA	50□A	50kA	50kA	50kA
	20A	40kA	40kA	40kA	40kA	50kA	50kA	50kA	50kA	50kA	50kA
	25A	40kA	40kA	40kA	40kA	50kA	50kA	50kA	50kA	50kA	50kA
	32A	40kA	40kA	40kA	40kA	50kA	50kA	50kA	50kA	50kA	50kA
	40A	40kA	40kA	40kA	40kA	50kA	50kA	50kA	50kA	50kA	50kA
	50A	40kA	40kA	40kA	40kA	50kA	50kA	50kA	50kA	30kA	30kA
	63A	40kA	40kA	40kA	40kA	50kA	50kA	50kA	50kA	30kA	30kA

		m.c.c.b. upstream										
		DPX / H / L 250 (Thermal-magnetic & electronic)						DPX / H / L 630 (Thermal-magnetic & electronic)				
		36 - 70 – 100kA						36 - 70 – 100kA				
m.c.b. downstream		25A	40A	63A	100A	160A	250A	250A	320A	400A	500A	630A
DX ³ 10000A B and C Curves	≤6A	50kA	50kA	50kA	50kA	50kA	50kA	50kA	50kA	50kA	50kA	50kA
	10A	50kA	50kA	50kA	50kA	50kA	50kA	50kA	50kA	50kA	50kA	50kA
	13A	50kA	50kA	50kA	50kA	50kA	50kA	50kA	50kA	50kA	50kA	50kA
	16A	50kA	50kA	50kA	50kA	50kA	50kA	50kA	50kA	50kA	50kA	50kA
	20A	50kA	50kA	50kA	50kA	50kA	50kA	50kA	50kA	50kA	50kA	50kA
	25A	-	50kA	50kA	50kA	50kA	50kA	50kA	50kA	50kA	50kA	50kA
	32A	-	50kA	50kA	50kA	50kA	50kA	50kA	50kA	50kA	50kA	50kA
	40A	-	-	50kA	50kA	50kA	50kA	50kA	50kA	50kA	50kA	50kA
	50A	-	-	30kA	30kA	30kA	30kA	30kA	30kA	30kA	30kA	30kA
	63A	-	-	-	30kA	30kA	30kA	30kA	30kA	30kA	30kA	30kA

All these values are also valid for circuit breakers associated to RCD add-on modules.

According to the curves and ratings of circuit breakers, attention to the magnetic (or electronic) threshold and to the size of upstream circuit breakers which must necessarily be higher.

Circuit breaker DX³ 10000 A up to 63A monoconnect (1 module per pole)

Cat. N° (s) : 4 088 64 to 4 093 42

5. GENERAL CHARACTERISTICS *(continued)*:

Coordination between modular circuit-breakers and M.C.C.Bs (Moulded Case Circuit Breakers), three-phase network (+ neutral) 230 / 240 V~ according to IEC/EN 60947-2:

		m.c.c.b. upstream	
		DPX / H / L 1250 (Thermal-magnetic)	DPX / H 1600 (electronic)
		50 – 70 – 100kA	36 – 70kA
m.c.b. downstream		500 to 1250A	630 to 1600A
DX ³ 10000A B and C Curves	≤6A	50kA	50kA
	10A	50kA	50kA
	13A	50kA	50kA
	16A	50kA	50kA
	20A	50kA	50kA
	25A	50kA	50kA
	32A	50kA	50kA
	40A	50kA	50kA
	50A	50kA	50kA
	63A	50kA	50kA

All these values are also valid for circuit breakers associated to RCD add-on modules.

According to the curves and ratings of circuit breakers, attention to the magnetic (or electronic) threshold and to the size of upstream circuit breakers which must necessarily be higher.

Circuit breaker DX³ 10000 A up to 63A monoconnect (1 module per pole)

Cat. N° (s) : 4 088 64 to 4 093 42

5. GENERAL CHARACTERISTICS *(continued)*

Selectivity between two levels of protection

- . The downstream circuit breaker must always have a magnetic threshold and a rated current lower than those of the upstream protection.
- . Selectivity is indicated total (T) if there is selectivity up to the value of breaking capacity (according to IEC / EN 60947-2) of the downstream circuit breaker.

Selectivity between modular circuit breakers and fuses:

- . Selectivity limit at 400V~: values in Ampere.

		Fuse upstream							
		gG Type							
m.c.b. downstream		32A	40A	50A	63A	80A	100A	125A	160A
DX ³ 10000A B and C Curves	≤6A	1300	1900	2500	4000	4600	T	T	T
	10A	-	1600	2200	3200	3600	7000	T	T
	13A	-	1400	1800	2600	3000	5600	8000	T
	16A	-	1400	1800	2600	3000	5600	8000	T
	20A	-	1200	1500	2200	2500	4600	6300	T
	25A	-	-	1300	2000	2200	4100	5000	9000
	32A	-	-	1200	1700	1900	3500	4500	8000
	40A	-	-	-	-	1700	3000	4000	6000
	50A	-	-	-	-	1600	2600	3500	5000
63A	-	-	-	-	2400	3300	5000	2400	

		Fuse upstream								
		aM Type								
m.c.b. downstream		25A	32A	40A	50A	63A	80A	100A	125A	160A
DX ³ 10000A B and C Curves	≤6A	1000	1600	2100	3200	6200	T	T	T	T
	10A	-	1000	1700	2500	5000	7800	T	T	T
	13A	-	1000	1400	2100	4000	6000	9000	T	T
	16A	-	1000	1400	2100	4000	6000	9000	T	T
	20A	-	-	1300	1800	3400	5100	7000	T	T
	25A	-	-	1100	1600	3000	4500	6000	9300	T
	32A	-	-	-	1300	2400	3800	5000	7700	9000
	40A	-	-	-	-	2100	3100	4200	6400	7000
	50A	-	-	-	-	2000	2900	3700	6000	6000
63A	-	-	-	-	-	2800	3500	5500	6000	

- . T = Total discrimination

Circuit breaker DX³ 10000 A up to 63A monoconnect (1 module per pole)

Cat. N° (s) : 4 088 64 to 4 093 42

5. GENERAL CHARACTERISTICS *(continued)*:

Selectivity between modular circuit breakers:

. Selectivity limit at 400V~: values in Ampere.

		m.c.b. upstream										
		DX ³ 25kA										
		B Curve										
m.c.b. downstream		10A	16A	20A	25A	32A	40A	50A	63A	80A	100A	125A
DX ³ 10000A B and C Curves	≤6A	-	64	80	100	700	1200	1500	3000	4000	T	T
	10A	-	-	80	100	500	700	1000	1800	3000	5000	T
	13A	-	-	-	100	400	600	900	1500	2500	4000	6000
	16A	-	-	-	-	300	500	700	1300	2000	3600	5500
	20A	-	-	-	-	-	400	500	1000	1600	3000	4000
	25A	-	-	-	-	-	-	500	800	1300	2400	3300
	32A	-	-	-	-	-	-	500	600	1000	1800	2700
	40A	-	-	-	-	-	-	-	600	800	1600	2400
	50A	-	-	-	-	-	-	-	-	800	900	1700
63A	-	-	-	-	-	-	-	-	-	900	1200	

. T = Total discrimination

Circuit breaker DX³ 10000 A up to 63A monoconnect (1 module per pole)

Cat. N° (s) : 4 088 64 to 4 093 42

5. GENERAL CHARACTERISTICS *(continued)*:

Selectivity between modular circuit breakers:

. Selectivity limit at 400V~: values in Ampere.

		m.c.b. upstream										
		DX ³ 25kA										
		C Curve										
m.c.b. downstream		10A	16A	20A	25A	32A	40A	50A	63A	80A	100A	125A
DX ³ 10000A B and C Curves	≤6A	75	120	150	187	700	1200	1500	3000	4000	T	T
	10A	-	120	150	187	500	700	1000	1800	3000	5000	T
	13A	-	120	150	187	400	600	1200	1500	2500	4000	6000
	16A	-	-	150	187	300	500	700	1300	2000	3600	5500
	20A	-	-	-	187	300	400	500	1000	1600	3000	4000
	25A	-	-	-	-	240	400	500	800	1300	2400	3300
	32A	-	-	-	-	-	300	500	600	1000	1800	2700
	40A	-	-	-	-	-	-	400	600	800	1600	2400
	50A	-	-	-	-	-	-	-	500	800	900	1700
	63A	-	-	-	-	-	-	-	-	650	900	1200

		m.c.b. upstream										
		DX ³ 25kA										
		D Curve										
m.c.b. downstream		10A	16A	20A	25A	32A	40A	50A	63A	80A	100A	125A
DX ³ 10000A B and C Curves	≤6A	120	192	240	500	700	1200	1500	3000	4000	T	T
	10A	-	192	240	300	500	700	1000	1800	3000	5000	T
	13A	-	-	240	300	400	600	1200	1500	2500	4000	6000
	16A	-	-	240	300	384	500	700	1300	2000	3600	5500
	20A	-	-	-	300	384	480	600	1000	1600	3000	4000
	25A	-	-	-	-	384	480	600	800	1300	2400	3300
	32A	-	-	-	-	-	480	600	756	1100	1450	2700
	40A	-	-	-	-	-	-	600	756	1000	1250	2400
	50A	-	-	-	-	-	-	-	756	950	1200	1700
	63A	-	-	-	-	-	-	-	-	950	1200	1500

. T = Total discrimination

Circuit breaker DX³ 10000 A up to 63A monoconnect (1 module per pole)

Cat. N° (s) : 4 088 64 to 4 093 42

5. GENERAL CHARACTERISTICS *(continued)*:

Selectivity between modular circuit breakers:

. Selectivity limit at 400V~: values in Ampere.

		m.c.b. upstream								
		DX ³ 36kA								
		C Curve								
m.c.b. downstream		10A	16A	20A	25A	32A	40A	50A	63A	80A
DX ³ 10000A B and C Curves	≤6A	75	120	170	500	700	1200	1500	3000	4000
	10A	-	120	150	210	500	700	1000	1800	3000
	13A	-	-	150	187	300	600	900	1500	2500
	16A	-	-	150	187	300	500	700	1300	2000
	20A	-	-	-	187	300	400	500	1000	1600
	25A	-	-	-	-	240	400	500	800	1300
	32A	-	-	-	-	-	300	500	600	1000
	40A	-	-	-	-	-	-	400	600	800
	50A	-	-	-	-	-	-	-	500	800
	63A	-	-	-	-	-	-	-	-	650

		m.c.b. upstream							
		DX ³ 50kA							
		B Curve							
m.c.b. downstream		10A	16A	20A	25A	32A	40A	50A	63A
DX ³ 10000A B and C Curves	≤6A	-	64	170	500	700	1200	1500	3000
	10A	-	-	150	210	500	700	1000	1800
	13A	-	-	-	200	400	600	1200	1500
	16A	-	-	-	-	300	500	700	1300
	20A	-	-	-	-	-	400	500	1000
	25A	-	-	-	-	-	-	500	800
	32A	-	-	-	-	-	-	500	600
	40A	-	-	-	-	-	-	-	600
	50A	-	-	-	-	-	-	-	-
	63A	-	-	-	-	-	-	-	-

. T = Total discrimination

Circuit breaker DX³ 10000 A up to 63A monoconnect (1 module per pole)

Cat. N° (s) : 4 088 64 to 4 093 42

5. GENERAL CHARACTERISTICS *(continued)*:

Selectivity between modular circuit breakers:

. Selectivity limit at 400V~: values in Ampere.

		m.c.b. upstream							
		DX ³ 50kA							
		C Curve							
m.c.b. downstream		10A	16A	20A	25A	32A	40A	50A	63A
DX ³ 10000A B and C Curves	≤6A	75	120	170	500	700	1200	1500	3000
	10A	-	120	150	210	500	700	1000	1800
	13A	-	120	150	200	400	600	1200	1500
	16A	-	-	150	187	300	500	700	1300
	20A	-	-	-	187	300	400	500	1000
	25A	-	-	-	-	240	400	500	800
	32A	-	-	-	-	-	300	500	600
	40A	-	-	-	-	-	-	400	600
	50A	-	-	-	-	-	-	-	500
	63A	-	-	-	-	-	-	-	-

		m.c.b. upstream							
		DX ³ 50kA							
		D Curve							
m.c.b. downstream		10A	16A	20A	25A	32A	40A	50A	63A
DX ³ 10000A B and C Curves	≤6A	120	192	240	500	700	1200	1500	3000
	10A	-	192	240	300	500	700	1000	1800
	13A	-	-	240	300	400	600	1200	1500
	16A	-	-	240	300	384	500	700	1300
	20A	-	-	-	300	384	480	600	1000
	25A	-	-	-	-	384	480	600	800
	32A	-	-	-	-	-	480	600	756
	40A	-	-	-	-	-	-	600	756
	50A	-	-	-	-	-	-	-	756
	63A	-	-	-	-	-	-	-	-

. T = Total discrimination

Circuit breaker DX³ 10000 A up to 63A monoconnect (1 module per pole)

Cat. N° (s) : 4 088 64 to 4 093 42

5. GENERAL CHARACTERISTICS (continued):

Selectivity between M.C.Bs and M.C.C.Bs (Moulded Case Circuit Breakers):

. Selectivity limit at 400V~: values in Ampere.

m.c.b. downstream		m.c.c.b. upstream										
		DPX 125						DPX 160				
		16 - 25 - 36kA						25 - 36 - 50kA				
		16A	25A	40A	63A	100A	125A	25A	40A	63A	100A	160A
DX ³ 10000A B and C Curves	≤6A	6000	6000	6000	6000	T	T	T	T	T	T	T
	10A	5000	5000	5000	5000	6000	6000	7500	7500	7500	7000	T
	13A	-	4000	4000	4000	6000	6000	7500	7500	7500	7000	T
	16A	-	4000	4000	4000	6000	6000	6000	6000	6000	6000	T
	20A	-	4000	4000	4000	5000	5000	-	5000	5000	5000	T
	25A	-	-	3000	3000	4500	4500	-	3500	3500	4000	8500
	32A	-	-	3000	3000	4000	4000	-	-	2000	3500	7000
	40A	-	-	-	3000	3000	3000	-	-	2000	2500	6000
	50A	-	-	-	-	3000	3000	-	-	-	2000	5500
	63A	-	-	-	-	3000	3000	-	-	-	2000	5000

m.c.b. downstream		m.c.c.b. upstream										
		DPX ³ 160 DPX ³ 160 + RCD								DPX 250ER		
		16 - 25 - 36 - 50kA								25 - 39 - 50kA		
		16A	25A	40A	63A	80A	100A	125A	160A	100A	160A	250A
DX ³ 10000A B and C Curves	≤6A	T	T	T	T	T	T	T	T	T	T	T
	10A	5000	T	T	T	T	T	T	T	T	T	T
	13A	-	T	T	T	T	T	T	T	T	T	T
	16A	-	T	T	T	T	T	T	T	T	T	T
	20A	-	5000	5000	5000	5000	6000	T	T	8000	T	T
	25A	-	-	4500	4500	4500	4500	T	T	6000	8500	T
	32A	-	-	-	3000	4000	4000	T	T	5000	7000	T
	40A	-	-	-	3000	3000	3000	T	T	4000	6000	T
	50A	-	-	-	-	3000	3000	5500	7000	4000	5500	7000
	63A	-	-	-	-	3000	3000	5000	6000	3000	5000	6000

. T = Total discrimination

Circuit breaker DX³ 10000 A up to 63A monoconnect (1 module per pole)

Cat. N° (s) : 4 088 64 to 4 093 42

5. GENERAL CHARACTERISTICS *(continued)*:

Selectivity between M.C.Bs and M.C.C.Bs (Moulded Case Circuit Breakers):

. Selectivity limit at 400V~: values in Ampere.

m.c.b. downstream		m.c.c.b. upstream									
		DPX 250ER AB				DPX 250 / H / L (Thermal-Magnetic & electronic)					
		25kA				36 - 70 - 100kA					
		90A	130A	170A	240A	25A	40A	63A	100A	160A	250A
DX ³ 10000A B and C Curves	≤6A	T	T	T	T	6000	6000	6000	T	T	T
	10A	T	T	T	T	5000	5000	5000	T	T	T
	13A	T	T	T	T	4000	4000	4000	T	T	T
	16A	T	T	T	T	4000	4000	4000	T	T	T
	20A	T	T	T	T	-	4000	4000	8000	T	T
	25A	T	T	T	T	-	3000	3000	6000	T	T
	32A	T	T	T	T	-	-	2000	5000	T	T
	40A	4000	T	T	T	-	-	2000	5000	T	T
	50A	4000	4000	T	T	-	-	-	4000	8000	T
	63A	3000	3000	T	T	-	-	-	4000	8000	T

m.c.b. downstream		m.c.c.b. upstream									
		DPX ³ 250 DPX ³ 250 + diff (Thermal-Magnetic & electronic)				DPX 400AB		DPX / H / L 630 (Thermal-Magnetic & electronic)		DPX / H / L 1250	DPX / H 1600 (electronic)
		25 - 36 - 50 - 70kA				36kA		36 - 70 - 100kA		36 - 70 - 100kA	36 - 70kA
		100A	160A	200A	250A	320A	400A	160 to 630A	500 to 1250A	630 to 1600A	
DX ³ 10000A B and C Curves	≤6A	T	T	T	T	T	T	T	T	T	
	10A	T	T	T	T	T	T	T		T	
	13A	T	T	T	T	T	T	T		T	
	16A	T	T	T	T	T	T	T	T	T	
	20A	8000	T	T	T	T	T	T	T	T	
	25A	6000	T	T	T	T	T	T	T	T	
	32A	5000	T	T	T	T	T	T	T	T	
	40A	5000	T	T	T	T	T	T	T	T	
	50A	4000	8000	T	T	T	T	T	T	T	
	63A	4000	8000	T	T	T	T	T	T	T	

. T = Total discrimination

Circuit breaker DX³ 10000 A up to 63A monoconnect (1 module per pole)

Cat. N° (s) : 4 088 64 to 4 093 42

5. GENERAL CHARACTERISTICS *(continued)*:

Selectivity between M.C.Bs and M.C.C.Bs (Moulded Case Circuit Breakers):

. Selectivity limit at 400V~: values in Ampere.

		m.c.c.b. upstream								
		DPX ³ 250 DPX ³ 250 + diff (Thermal-Magnetic & electronic)				DPX 400AB		DPX / H / L 630 (Thermal-Magnetic & electronic)	DPX / H / L 1250	DPX / H 1600 (electronic)
		25 - 36 - 50 - 70kA				36kA		36 - 70 - 100kA	36 - 70 - 100kA	36 - 70kA
m.c.b. downstream		100A	160A	200A	250A	320A	400A	160 to 630A	500 to 1250A	630 to 1600A
DX ³ 10000A B and C Curves	≤6A	T	T	T	T	T	T	T	T	T
	10A	T	T	T	T	T	T	T		T
	13A	T	T	T	T	T	T	T		T
	16A	T	T	T	T	T	T	T	T	T
	20A	8000	T	T	T	T	T	T	T	T
	25A	6000	T	T	T	T	T	T	T	T
	32A	5000	T	T	T	T	T	T	T	T
	40A	5000	T	T	T	T	T	T	T	T
	50A	4000	8000	T	T	T	T	T	T	T
	63A	4000	8000	T	T	T	T	T	T	T

. T = Total discrimination

Circuit breaker DX³ 10000 A up to 63A monoconnect (1 module per pole)

Cat. N° (s) : 4 088 64 to 4 093 42

6. COMPLIANCE AND APPROVALS

In accordance with standards:

- . EN/IEC 60898-1 with 10000A breaking capacity
- . CEE guidelines : 73/23/CEE + 93/68/CEE
- . Legrand circuit-breakers can be used under the conditions of use as defined by EN/IEC 60947.
- . The performance of circuit breakers can be influenced by particular climates: hot dry, cold dry, hot humid, salt fog atmosphere

Classification according to Annex Q (standard IEC/EN 60947-1) :

- . Category C with a range test temperature -25 °C / +70 °C
- . salt fog atmosphere according IEC 60068-2-52

Environment respect – Compliance with CEE directives:

- . Compliance with Directive 2002/95/EC of 27/01/03 called "RoHS" which provides for the banning of hazardous substances such as lead, mercury, cadmium, hexavalent chromium, brominated flame retardants polybrominated biphenyls (PBBs) and polybrominated diphenyl ethers (PBDEs) from 1st July 2006
- . Compliance with Directive 91/338/CEE of 18/06/91 and Decree 94-647 of 27/07/04

Plastic materials :

- . Halogens-free plastic materials.
- . Marking of parts according to ISO 11469 and ISO 1043.

Packaging:

- . Design and manufacture of packaging in accordance with Decree 98-638 of 07.20.98 and Directive 94/62/EC

Circuit breaker DX³ 10000 A up to 63A monoconnect (1 module per pole)

Cat. N° (s) : 4 088 64 to 4 093 42

7. CHARACTERISTIC CURVES

Limiting current curve: circuit breakers B and C curves:

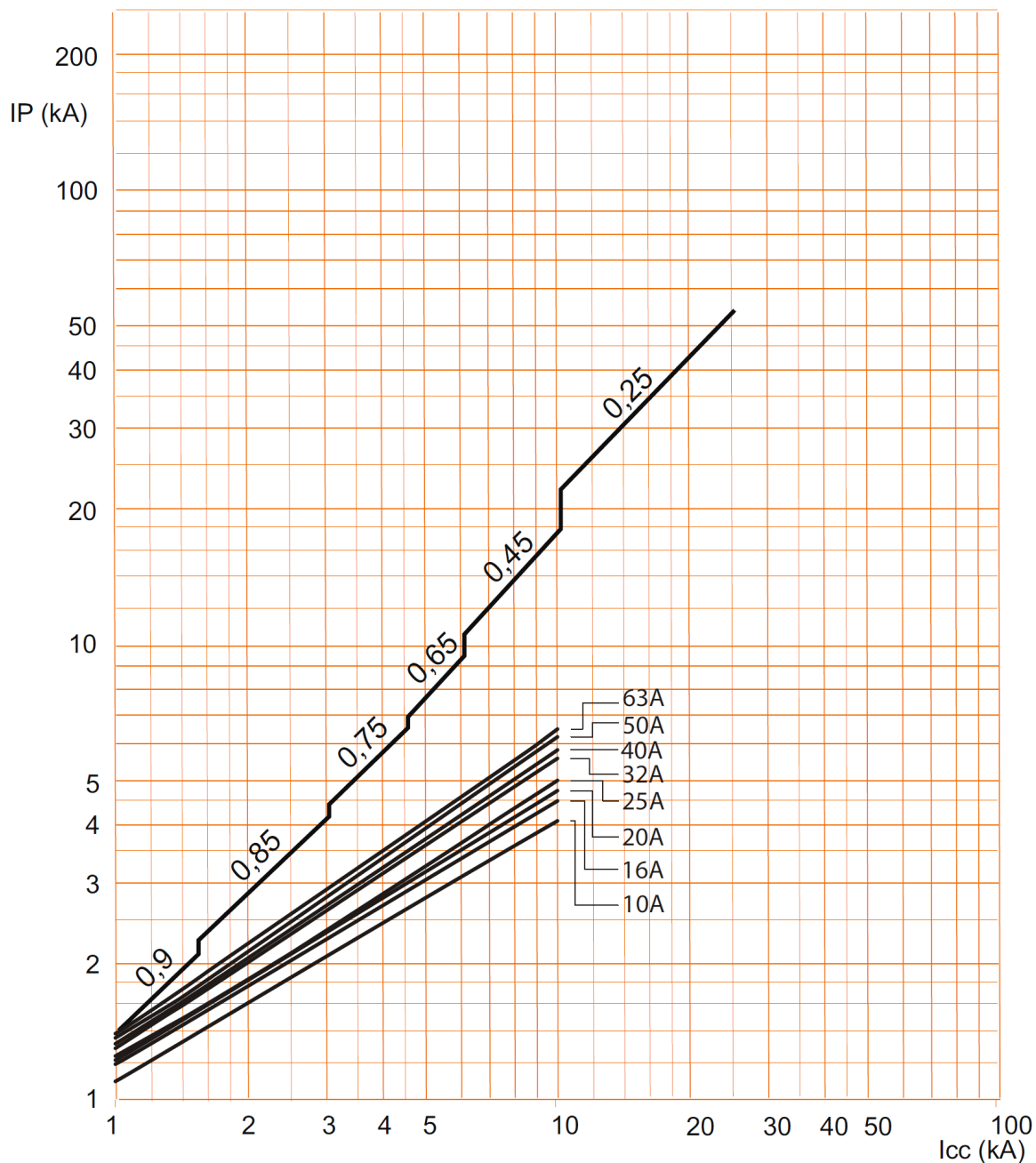

- . Icc = Square value of symmetric component of the short circuit current (kA).
- . IP = Max peak value (kA)

Circuit breaker DX³ 10000 A up to 63A monoconnect (1 module per pole)

Cat. N° (s) : 4 088 64 to 4 093 42

7. CHARACTERISTIC CURVES (continued)

Operating characteristic of circuit breakers B curve:

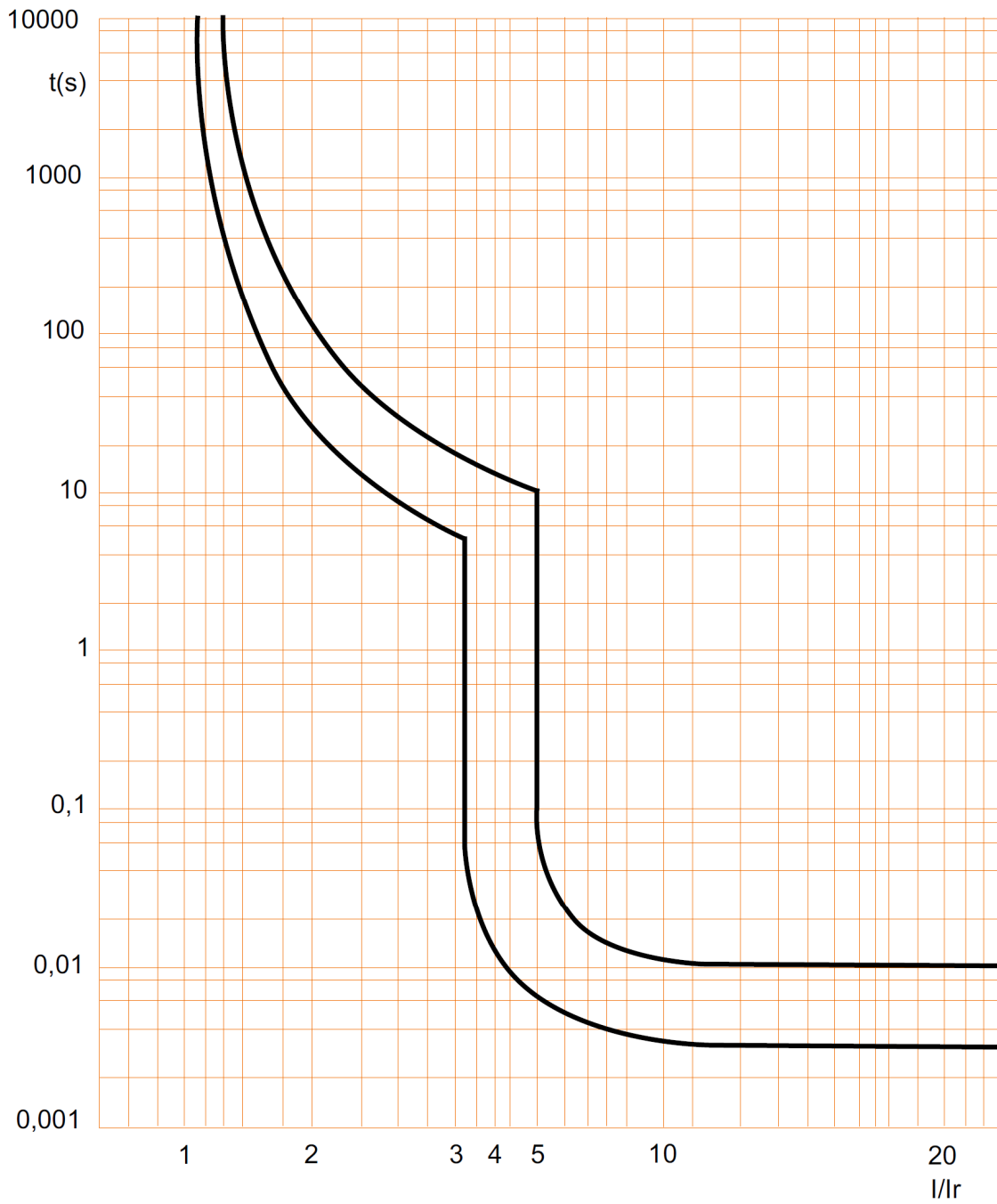

7. CHARACTERISTIC CURVES (continued)

. Limiting thermal energy curve of circuit breakers B curve, 2P (230V~ / 50Hz):

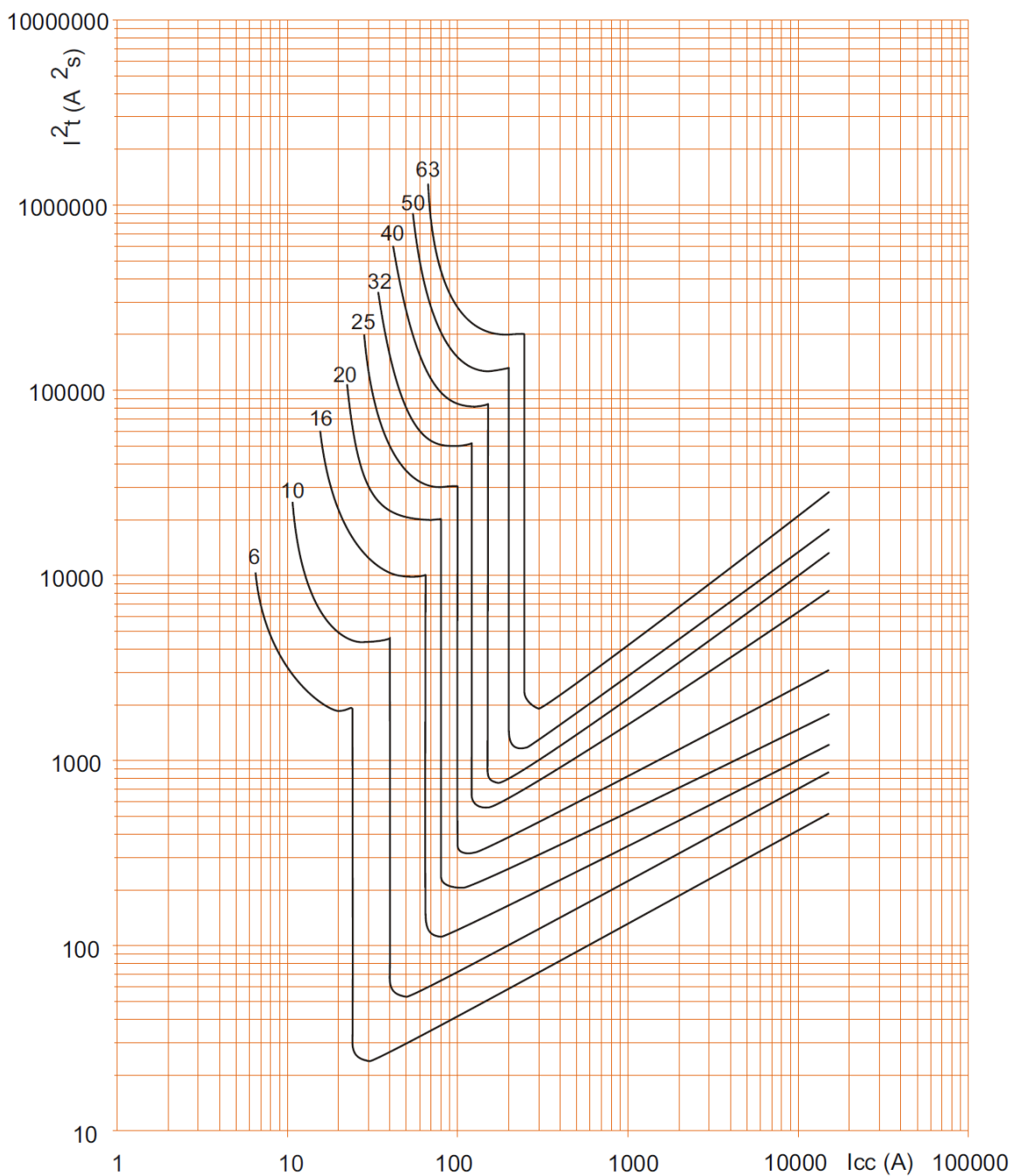

. Icc = Square value of symmetric component of the short circuit current (kA).

. I²t = Thermal energy limited (A²s).

7. CHARACTERISTIC CURVES (continued)

. Limiting thermal energy curve of circuit breakers B curve, 2P (400V~ / 50Hz) :

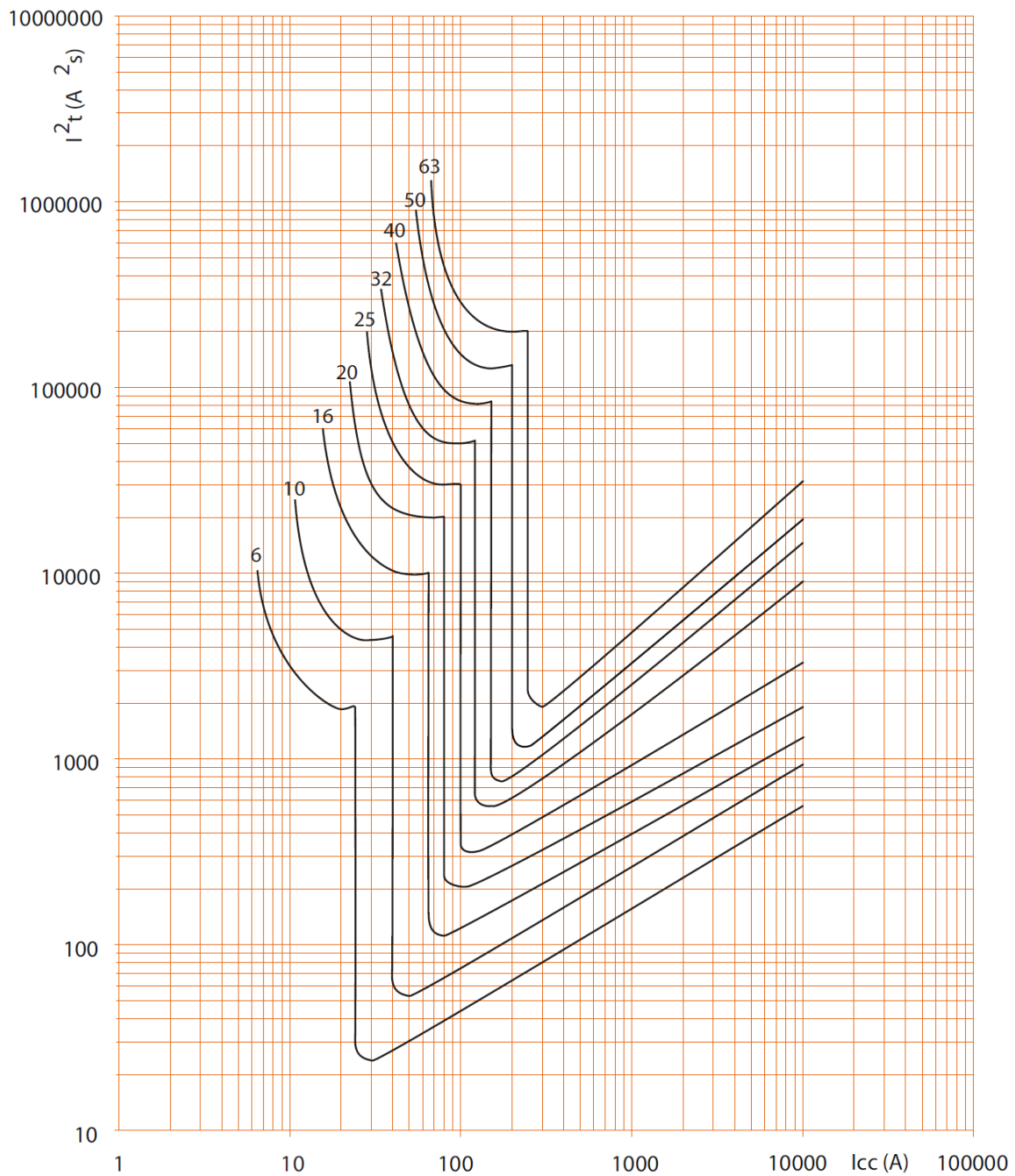

. I_{cc} = Square value of symmetric component of the short circuit current (kA).

. I^2t = Thermal energy limited (A^2s).

7. CHARACTERISTIC CURVES (continued)

. Limiting thermal energy curve of circuit breakers B curve, 3P / 4P (400V~ / 50Hz) :

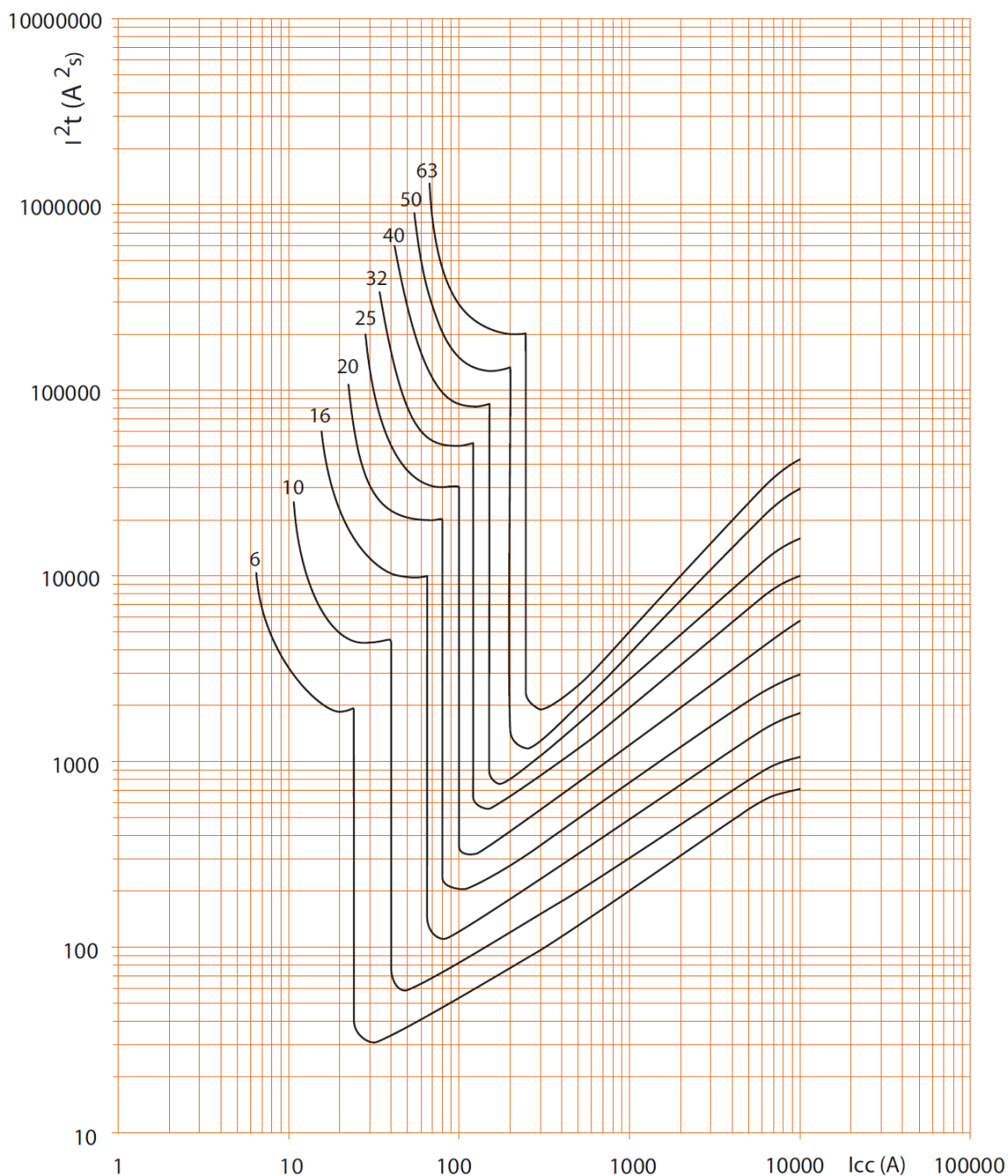

. I_{cc} = Square value of symmetric component of the short circuit current (kA).
. I^2t = Thermal energy limited (A^2s).

7. CHARACTERISTIC CURVES (continued)

Operating characteristic of circuit breakers C curve:

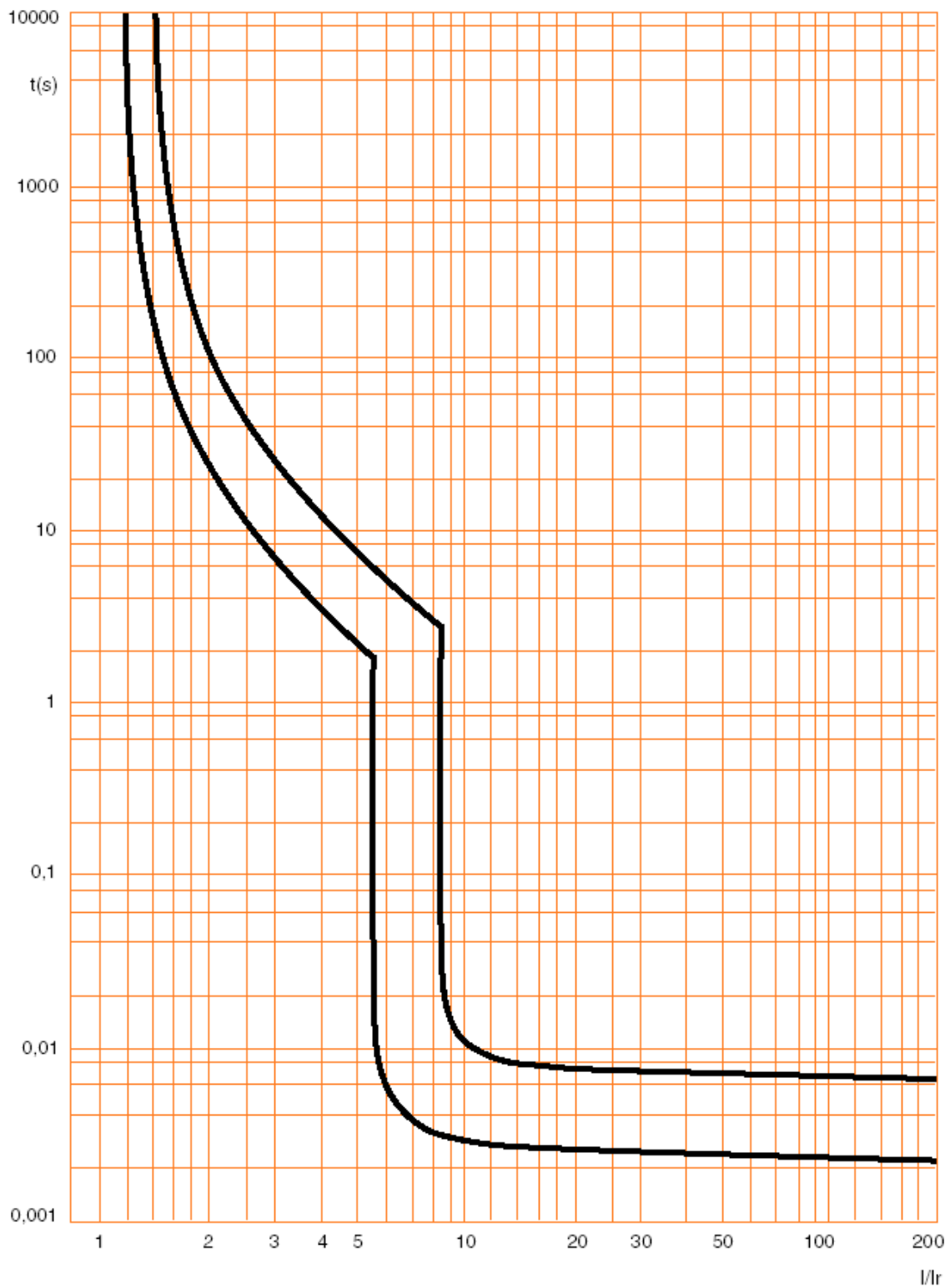

Circuit breaker DX³ 10000 A up to 63A monoconnect (1 module per pole)

Cat. N° (s) : 4 088 64 to 4 093 42

7. CHARACTERISTIC CURVES *(continued)*

. Limiting thermal energy curve of circuit breakers C curve , 2P (230V~ / 50Hz) :

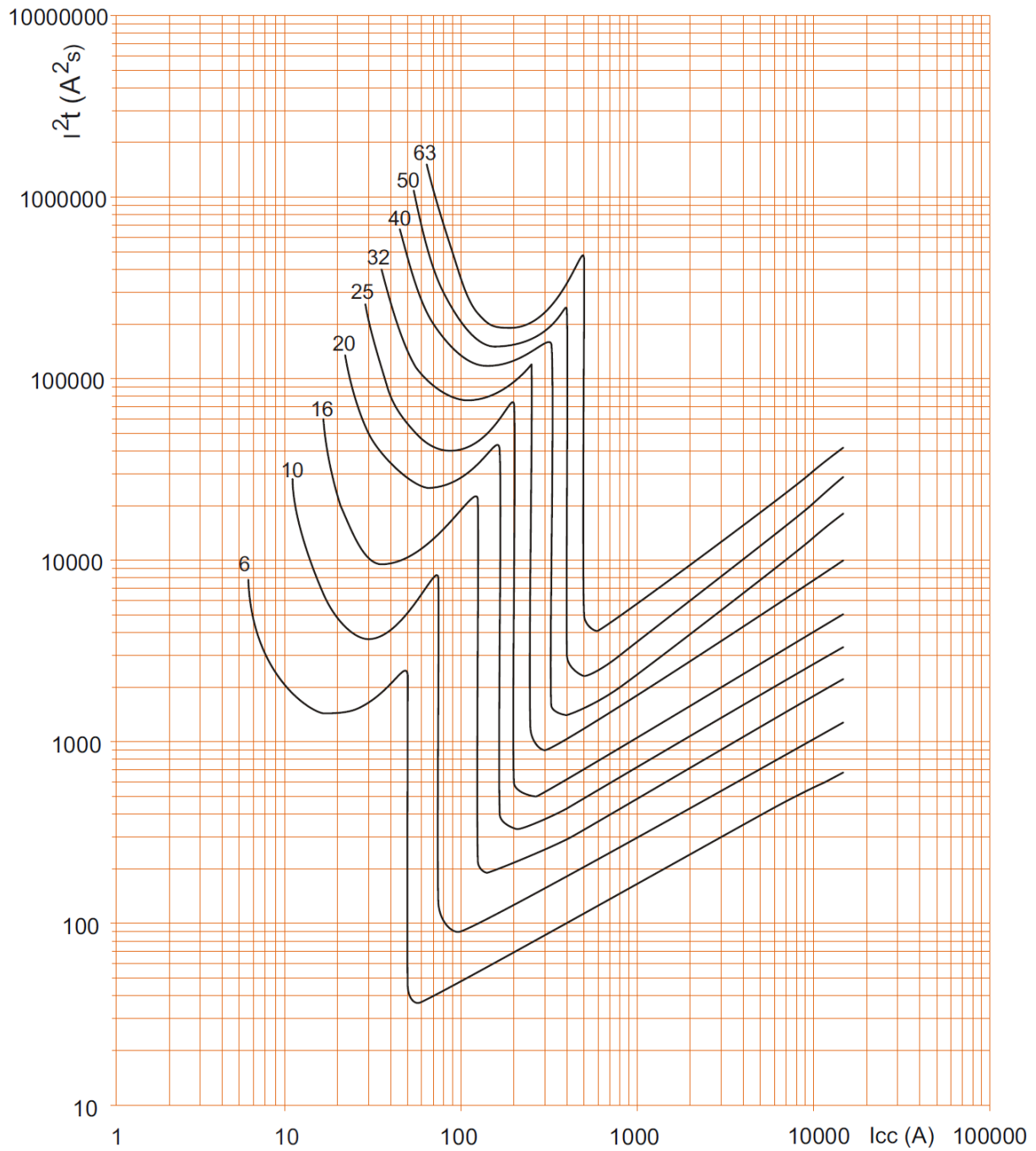

. I_{cc} = Square value of symmetric component of the short circuit current (kA).

. I^2t = Thermal energy limited (A^2s).

Circuit breaker DX³ 10000 A up to 63A monoconnect (1 module per pole)

Cat. N° (s) : 4 088 64 to 4 093 42

7. CHARACTERISTIC CURVES (continued)

. Limiting thermal energy curve of circuit breakers C curve , 2P (400V~ / 50Hz) :

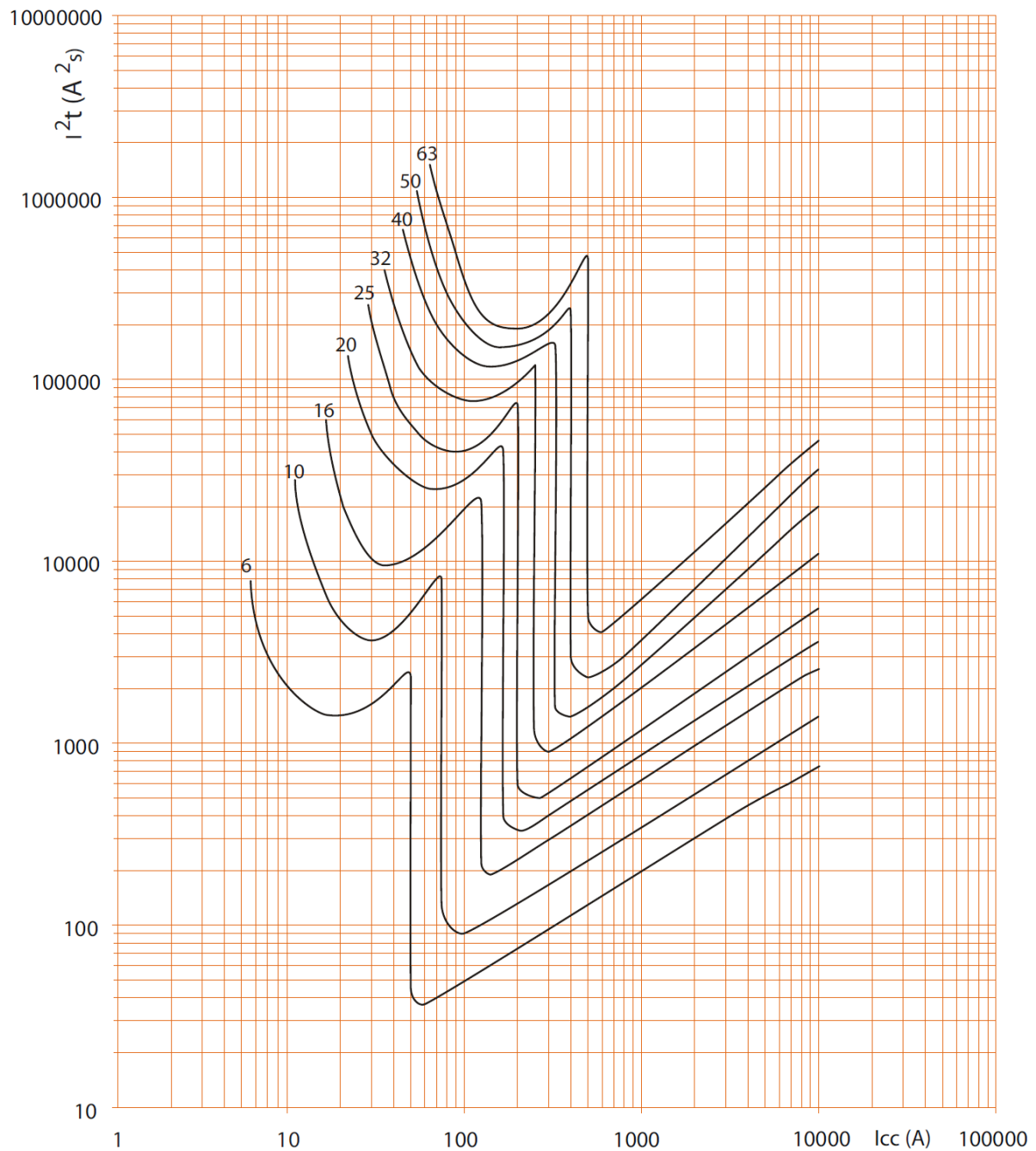

. I_{cc} = Square value of symmetric component of the short circuit current (kA).

. I^2t = Thermal energy limited (A^2s).

Circuit breaker DX³ 10000 A up to 63A monoconnect (1 module per pole)

Cat. N° (s) : 4 088 64 to 4 093 42

7. CHARACTERISTIC CURVES *(continued)*

. Limiting thermal energy curve of circuit breakers C curve , 1P / 3P / 4P (400V~ / 50Hz) :

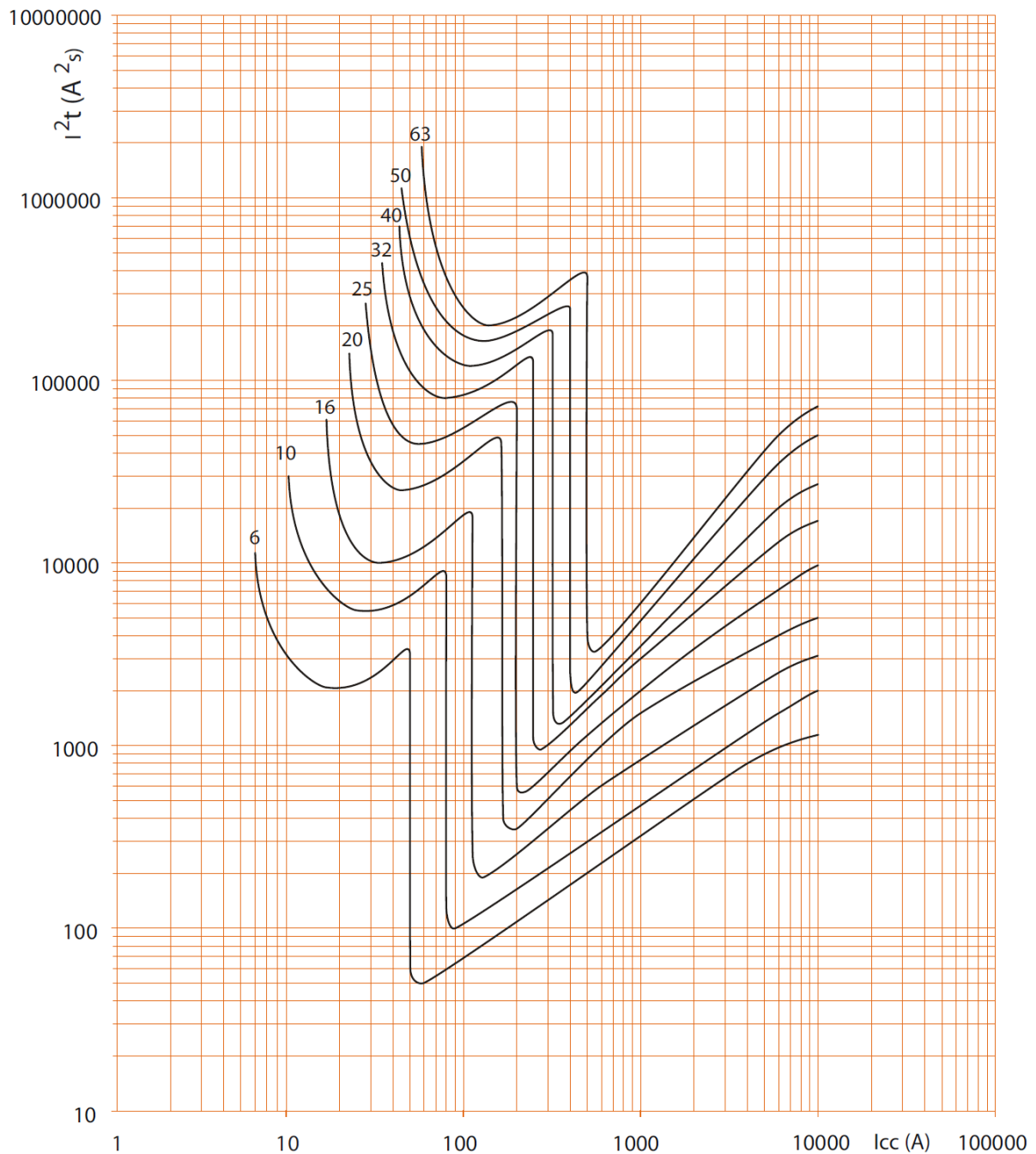

. I_{cc} = Square value of symmetric component of the short circuit current (kA).

. I^2t = Thermal energy limited (A^2s).

Circuit breaker DX³ 10000 A up to 63A monoconnect (1 module per pole)

Cat. N° (s) : 4 088 64 to 4 093 42

8. AUXILIARIES AND ACCESSORIES

Coupling with RCD add-on modules up to 63A:

m.c.b.	r.c.d.		
	2P	3P	4P
2P	X	-	-
3P	-	X	-
4P	-	-	X

Wiring accessories:

- . Pin busbar HX³ traditional.
- . Sealable screw cover (cat n° 4 063 04).
- . Insulating shields (cat n° 4 063 05)
- . Dispatcher row Lexiclic
- . Dispatcher row HX³.

Signal auxiliaries:

- . Auxiliary contact (½ module – cat n° 4 062 58).
- . Fault signalling changeover switch (½ module – cat n° 4 062 60).
- . Auxiliary contact modifiable in default signal (½ module – cat n° 4 062 62).
- . Auxiliary contact + fault signalling switch - can be modified to 2 auxiliary contacts (1 module - cat n° 4 062 66).

Control auxiliaries:

- . Shunt releases (1 module - cat n° 4 062 76 /78).
- . Under voltage release (1 module - cat n° 4 062 80 /82).
- . Overvoltage release (1 module – cat n° 4 062 86).
- . Autonomous shunt trip for NC push-button (1 module - cat n° 4 062 84 / 87).

Motor driven control modules

- . Motor driven control 24-48V / 230V (1 module – cat n° 4 062 90 /91)
- . Motor driven control module with automatic resetting integrated (2 modules – cat n° 4 062 93 /95)

Possible combinations of m.c.b and auxiliaries:

- . Auxiliaries are clipped on the left of the m.c.b.
- . Maximum number of auxiliaries for one circuit-breaker: 3.
- . Two signalling auxiliaries max. (cat. n° 4 062 58 /60 /62 /66).
- . Only one control auxiliary (cat. n° 4 062 76 / 78 / 80 / 82 / 84 / 86 /87).
- . One remote control or Stop & Go motor driven remote control
- . If signalling and control auxiliaries are associated on the same circuit breaker, the command auxiliary must be placed to the left of the signal auxiliary

8. AUXILIARIES AND ACCESSORIES (continued)

Sealing:

- . Possible in "Open" position (OFF) or "Close" position (ON).

Locking:

- . By 5 mm padlock (cat. N° 4 063 13) or 6 mm padlock (cat. N° 0 227 97) with padlock support (cat. N° 0 044 42) in "Open" position (OFF).

Installation software:

- . XL PRO³