

208 48/49

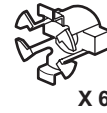

X 6

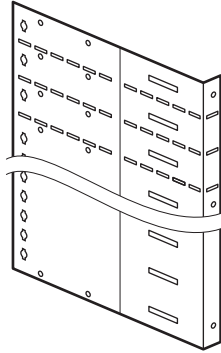
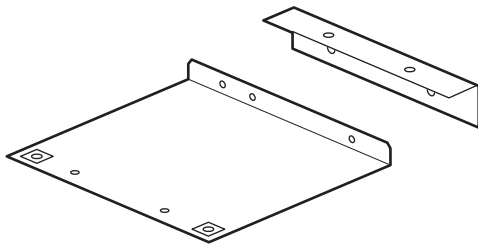
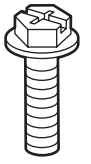

M6 x 12
X 24

2b/3b

208 37/38

208 93/94

208 48/49

208 77/78/79

208 93/94

208 37/38

208 48/49

208 77/78/79

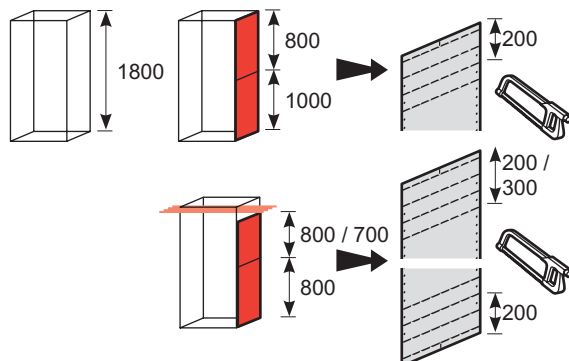
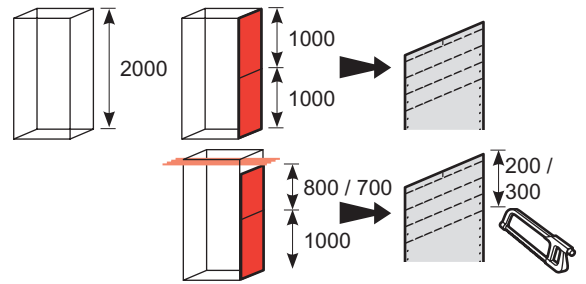

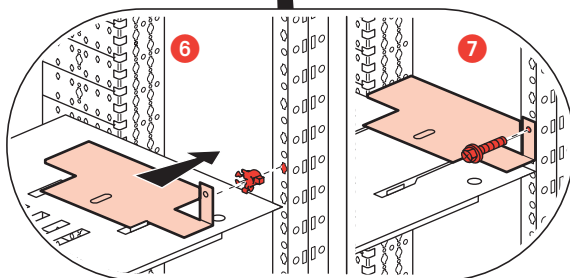
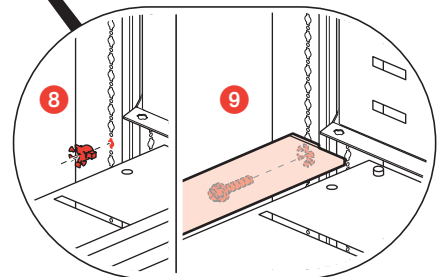
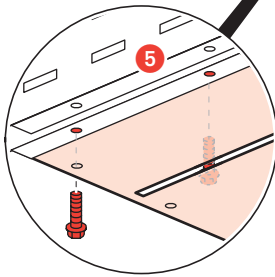
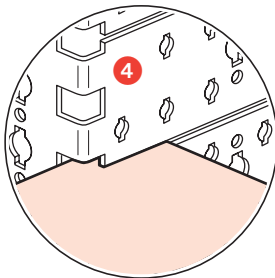
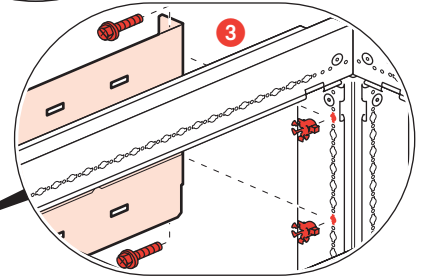
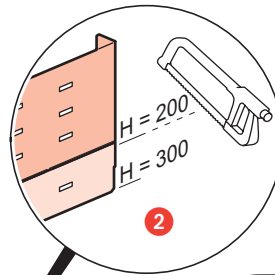
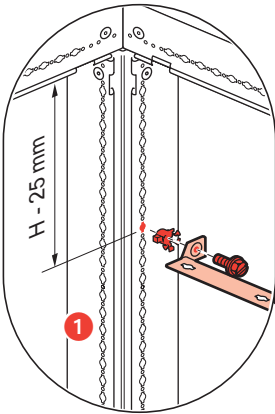
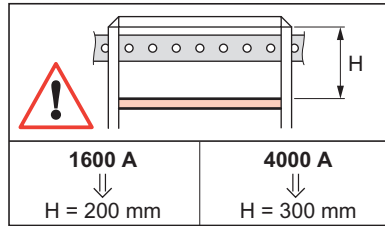
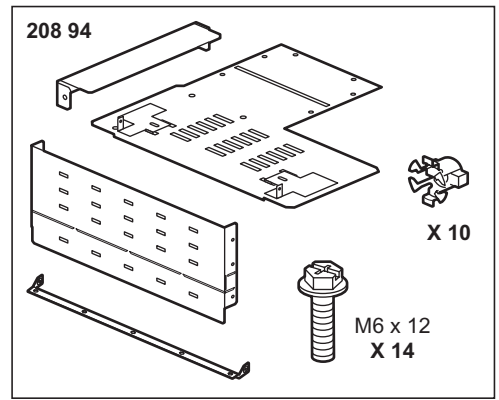
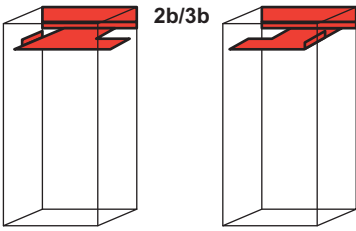

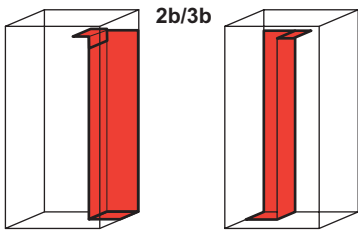

2b/3b

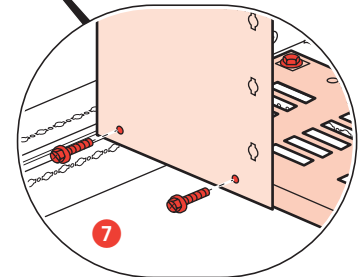
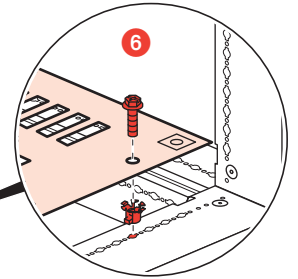
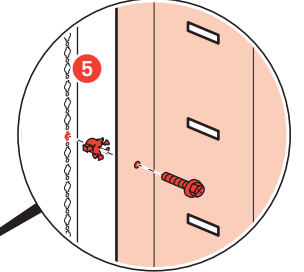
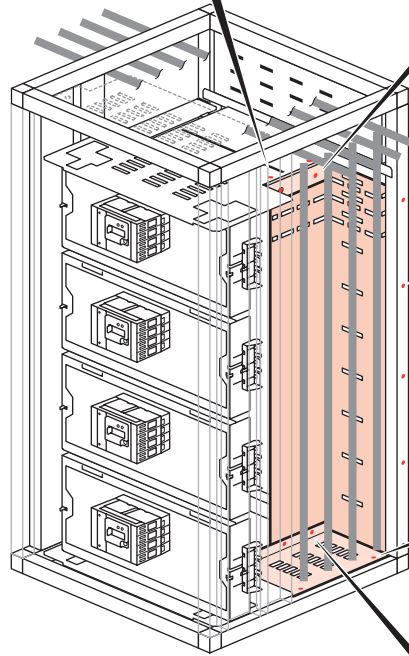
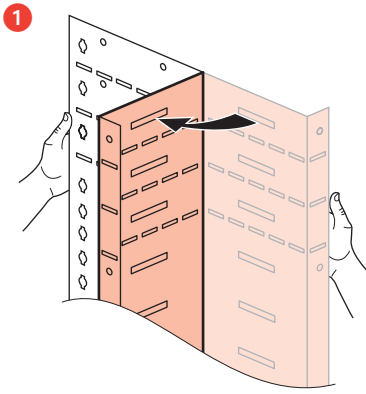
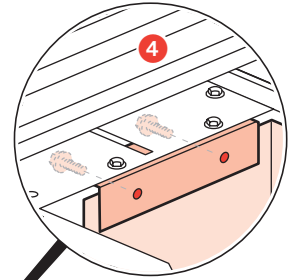
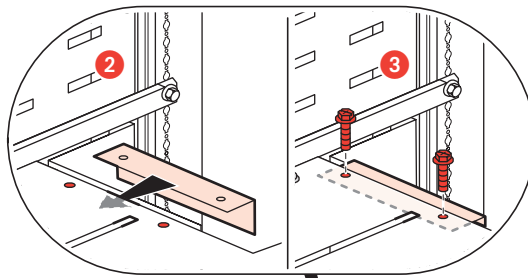

H

1600 A	4000 A
H = 200 mm	H = 300 mm

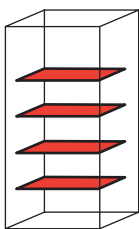

3b

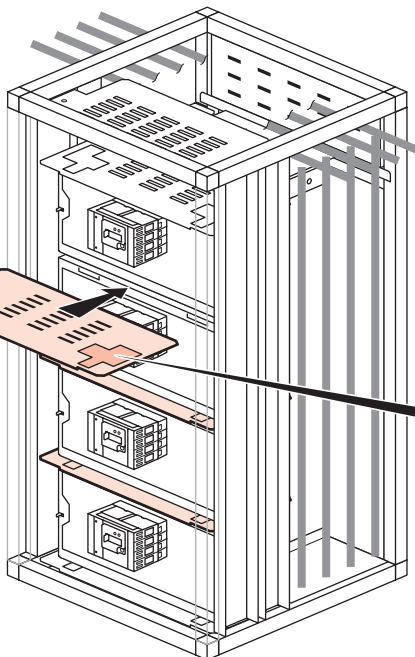

208 92

